

**A METHODOLOGY FOR UNCERTAINTY QUANTIFICATION IN
QUANTITATIVE TECHNOLOGY VALUATION BASED ON
EXPERT ELICITATION**

A Dissertation
Presented to
The Academic Faculty

by

Muhammad Farooq Bin Akram

In Partial Fulfillment
of the Requirements for the Degree
Doctor of Philosophy in the
School of Aerospace Engineering

Georgia Institute of Technology
May 2012

COPYRIGHT © 2012 BY MUHAMMAD FAROOQ BIN AKRAM

**A METHODOLOGY FOR UNCERTAINTY QUANTIFICATION IN
QUANTITATIVE TECHNOLOGY VALUATION BASED ON
EXPERT ELICITATION**

Approved by:

Dr. Dimitri Mavris, Advisor
School of Aerospace Engineering
Georgia Institute of Technology

Dr. Daniel P. Schrage
School of Aerospace Engineering
Georgia Institute of Technology

Dr. Brian German
School of Aerospace Engineering
Georgia Institute of Technology

Mr. Russell Denney
School of Aerospace Engineering
Georgia Institute of Technology

Dr. Frederic Villeneuve
Siemens Energy Inc.

Date Approved: November 22, 2011

ACKNOWLEDGEMENTS

I would like to express my profound gratitude to my advisor, Dr. Dimitri Mavris for his support, guidance and inspiration on each phase of my work. I appreciate the opportunities he has afforded me for my research, professional development and academics. He has always been a strong motivational figure along the way. I will always be indebted to him for teaching me the philosophy of research and inculcating a constant urge for academic excellence.

I would like to thank my committee members Dr. Brian German, Dr. Daniel P. Schrage and Russell Denney for their time and feedback, whenever I needed. I would also like to make a special mention of Dr. Frederic Villeneuve for his great support during my stay at Georgia Tech. I have always enjoyed long academic discussions with him, directly or indirectly related to my research topic. Many of the ideas which came under discussion during our meetings helped shape my research. His great personality and way of discussions made the process lot more enjoyable.

I consider myself extremely privileged to be a part of a great team at Aerospace systems design lab (ASDL). I had a good time working with ASDL research faculty members including Dr. Simon Briceno, Dr. Pfaender Holger and Dr. Rallabhandi. During graduate school I have always enjoyed great company and technical discussions with Matt Prior, Alexia Payan, Chul Hwa, Zohaib Mian, Joseph Iacobucci, Curtis Iwata and many others.

I would also want to take this opportunity to thank Dr. J. I. Jagoda and all administrative staff of School of Aerospace Engineering, especially Loretta Carroll for their continued support during my stay at Georgia Tech.

I am also extremely fortunate to have the support of a number of individuals outside of the lab as well. I would like to thank my friends Tahir Zaidi, Qaisar Chaudary, Jehanzeb Burki, Nadeem Shafi, Salman Aslam, Irtiza Shah, Tauseef ur Rehman, Ali Hashmi, Irtiza Khan, Faisal Siddiqui, Azhar Hassan, Manzar Abbas, Fawad Niazi, Adeel Yusuf, Aleem Mushtaq, Murtaza Askari and many others.

I would like to especially thank my parents for their undying support and belief in me. Their prayers and guidance have always been with me at each step of my life.

Finally, I am heartily thankful to my wife and kids for their support and love. My wife has been instrumental in my ability to complete my research. She has always provided encouragement, personal sacrifices and patience throughout my studies. Thanks you for being such a great part of this journey.

TABLE OF CONTENTS

ACKNOWLEDGEMENTS.....	III
LIST OF TABLES	VIII
LIST OF FIGURES	IX
NOMENCLATURE	XIII
SUMMARY	XIV
CHAPTER 1: UNCERTAINTIES IN KNOWLEDGE ELICITATION.....	1
Knowledge and its applications.....	1
Types of Knowledge.....	1
Ignorance	5
Expert Elicitation Concepts	7
Types of Uncertainties in Elicitation	12
Classification of Uncertainty	12
Uncertainty Modeling and propagation	16
CHAPTER 2: EXPERT ELICITATION PROCESS.....	41
Preparation background.....	41
Expert recruitment.....	41
Expert training.....	42
Structuring the elicitation	43
Elicitation	44
CHAPTER 3: APPLICATION OF DEMPSTER-SHAFER THEORY OF EVIDENCE.....	46
Problem Setup.....	46
Results.....	49
Sensitivity Analysis	49
Combination of Evidence	51
Sample Size Sensitivity	53
Cumulative distributions	53

CHAPTER 4: TECHNOLOGY MODELING WITH TECHNOLOGY SYNERGY MATRICES.....	59
Problems with Current Methodologies.....	59
Approach Description	61
Technology Impact Matrices (TIM)	62
Technology Compatibility Matrices (TCM).....	63
Technology Synergy Matrices (TSM)	64
Technology Evaluation and Selection	71
Experiment Setup	72
Results	73
CHAPTER 5: FINANCIAL MODELING	77
Real Options Process.....	77
Value Model	77
Sensitivity Analysis	78
Volatility calculations.....	78
Problem Definition	78
Modeling and analysis	78
Decision Making and Process Review	79
CHAPTER 6: METHODOLOGY	81
Technology Forecasting Methodology.....	81
Creation of M&S Environment	81
Expert elicitation and Technology Modeling	82
Financial Modeling.....	82
Uncertainty propagation	83
Quantification of Epistemic Uncertainties in Multidisciplinary Environments	83
Modeling and Simulation: Multidisciplinary Environment for Power Generation System...85	
Surrogate Model	87
Technology Modeling	96
Uncertainty propagation	103
CHAPTER 7: RESULTS AND DISCUSSIONS.....	106

Interval Analysis	106
Dempster-Shafer Theory of Evidence	107
Cumulative Belief and Plausibility Distributions (CBF, CPF)	108
Complementary Cumulative Belief and Plausibility Distributions (CCBF, CCPF)	109
Impact of Input Intervals Settings on Response Distributions.....	110
Uncertainty Quantification through DAKOTA.....	112
Combined Results: Individual Technologies/ Portfolios.....	125
TECH01: Advanced Burner Concept	125
TECH07: Compressor performance improvement	128
TECH16: Turbine cooling system improvement.....	130
TECH23: Material Systems Technology.....	133
TECH34: Advanced Turbine Airfoils	137
Portfolio 1: TECH07 and TECH16	139
Portfolio 2: TECH01, TECH07, TECH16, TECH23, TECH34	140
Decision Making under Uncertainty	146
Discussions on Technology Insertion Based on Technology Readiness Level.....	155
CHAPTER 8: CONCLUSIONS.....	158
Knowledge and experts	158
Uncertainty propagation.....	159
Technology interactions	161
Large Scale Example Application	162
Future Work	163
Summary of Contributions.....	164
APPENDIX A: INTRODUCTION TO DAKOTA	166
APPENDIX B: SAMPLE INPUT FILES FOR UNCERTAINTY QUANTIFICATION	168
APPENDIX C: OUTPUT RESULTS FILES.....	174
REFERENCES	198

LIST OF TABLES

Table 1: Calculations for Dempster’s rule of Combination (Two Experts).....	32
Table 2 : Baseline Engine Performance	47
Table 3: Candidate Technologies	48
Table 3 : Intervals of Percent Uncertainty Used in Evidence Theory	49
Table 4: Baseline Aircraft Assumptions.....	72
Table 6. Selected portfolios based on best cruise performance	76
Table 7 : Statistical Metric of Electrical Net Efficiency.....	93
Table 8 : Statistical Metric of Electrical Net Power	94
Table 9: Deterministic Technology Impacts of Material Systems Technology.....	100
Table 10: Technology Impacts of Material Systems Technology	101
Table 11: Technology Impact for Heat Conductivity of Vane 1 for Evidence Theory	102
Table 12: Technology Impact for Heat Conductivity of Vane 2 for Evidence Theory	102
Table 13: Technology Impact for Heat Conductivity of Blade 1 for Evidence Theory	103
Table 14: Technology Impact for Heat Conductivity of Blade 2 for Evidence Theory	103
Table 15 : Results for Interval Analysis	106
Table 16: Intervals and Associated BPAs for Evidence analysis	108
Table 17: Intervals and Associated BPAs for Evidence analysis	108

LIST OF FIGURES

Figure 1: Sources and categories of knowledge [8].....	4
Figure 2. Classification of Ignorance [11].....	7
Figure 3. View of modeling and simulation by the Society of Computer Simulation [23]	13
Figure 4. Second-order Probability [26].....	21
Figure 5: Intervals for uncertain variables and their associated BPAs	25
Figure 6: Belief and plausibility in evidence theory [49]	27
Figure 7: Aggregation of Evidence from Multiple Experts.....	31
Figure 8: Dempster-Shafer Analysis of Shear Mode Frequency	33
Figure 9: Expert Elicitation Process	44
Figure 10 : Baseline Engine Flow Path and Architecture.....	47
Figure 11: Sensitivity analysis for TSFC	50
Figure 12: Sensitivity analysis for Thrust-to-Weight Ratio.....	51
Figure 13: Intervals and associated BPAs for percent variation of combustor efficiency from baseline	52
Figure 14: Plot of resulting BPA from Dempster Rule	52
Figure 15: Cumulative belief and plausibility distributions for thrust-to-weight ratio.....	53
Figure 16: Effect of sample size on simulation time	54
Figure 17 : Cumulative belief and plausibility distributions for Specific Thrust	55
Figure 18 : Cumulative belief and plausibility distributions for TSFC	55
Figure 19 : Cumulative belief and plausibility distributions for Total Engine Weight	56
Figure 20. Cumulative belief and plausibility distributions for Thrust to Weight Ratio	57
Figure 21. Notional Comparison of Current and Proposed Methodologies for the Modeling of Technology Combinations.....	61
Figure 22. Notional Technology Impact Matrix.....	62
Figure 23. Notional Technology Compatibility Matrix.....	63
Figure 24. Notional Technology Synergy Matrix.....	66
Figure 25. Integration of TSM in Technology Evaluation	71
Figure 26. Comparison between TSM methods application.....	73
Figure 27. Pareto Front for Final Case	74
Figure 28. Pareto Front for Extreme Case.....	75
Figure 29. Options Valuation Process	79

Figure 30. Uncertainty Propagation in Technology Valuation.....	83
Figure 31. Multidisciplinary Environment	84
Figure 32. Interval specification for Dempster-Shafer theory of evidence	85
Figure 33. Multidisciplinary Environment for Combined Cycle Power Plant	87
Figure 34. The Generic Neural Network.....	89
Figure 35. : Actual by Predicted Plot of Electrical Net Efficiency.....	94
Figure 36. : Residual by Predicted Plot of Electrical Net Efficiency	95
Figure 37. : Actual by Predicted Plot of Electrical Net Power	95
Figure 38. Residual by Predicted Plot of Electrical Net Power.....	96
Figure 39. Integrated environment for technology valuation	97
Figure 40: Material Systems Technology [111].....	99
Figure 41: Intervals and Associated BPAs for Evidence analysis.....	107
Figure 42: Intervals and Associated BPAs for Evidence analysis.....	108
Figure 43. Cumulative Belief and Plausibility Distributions [Bel ($x \leq x$), Pl($x \leq x$)] for Efficiency Improvement.....	109
Figure 44. Cumulative Belief and Plausibility Distributions [Bel ($x > x$) or Pl($x > x$)] for Efficiency Improvement.....	110
Figure 45. Comparison between different interval settings: Complementary Cumulative belief and plausibility distributions [Bel ($\tilde{x} > x$) or Pl($\tilde{x} > x$)] for Power Improvement.....	111
Figure 46. DAKOTA setup for automated iterative analysis	112
Figure 47: Advanced Burner Concept [122]	126
Figure 48. Uncertainty Propagation in Technology Valuation for TECH01: Plots of CCBF and CCPF [Bel ($x > x$) or Pl($x > x$)] for Efficiency.....	127
Figure 49. Uncertainty Propagation in Technology Valuation for TECH01: Plots of CCBF and CCPF [Bel ($x > x$) or Pl($x > x$)] for Power	128
Figure 50: Compressor Performance Improvement [123].....	129
Figure 51. Uncertainty Propagation in Technology Valuation for TECH07: Plots of CCBF and CCPF [Bel ($x > x$) or Pl($x > x$)] for Efficiency.....	129
Figure 52. Uncertainty Propagation in Technology Valuation for TECH07: Plots of CCBF and CCPF [Bel ($x > x$) or Pl($x > x$)] for Power	130
Figure 53: Turbine Cooling System improvement [124]	131

Figure 54. Uncertainty Propagation in Technology Valuation for TECH16: Plots of CCBF and CCPF [Bel ($x > x$) or $Pl(x > x)$] for Efficiency	132
Figure 55. Uncertainty Propagation in Technology Valuation for TECH16: Plots of CCBF and CCPF [Bel ($x > x$) or $Pl(x > x)$] for Power	133
Figure 56: Material Systems Technology [125]	134
Figure 57. Uncertainty Propagation in Technology Valuation for TECH23: Plots of CBF and CPF [Bel ($x \leq x$), $Pl(x \leq x)$] for Efficiency	135
Figure 58. Uncertainty Propagation in Technology Valuation for TECH23: Plots of CCBF and CCPF [Bel ($x > x$) or $Pl(x > x)$] for efficiency	136
Figure 59. Uncertainty Propagation in Technology Valuation for TECH23: Plots of CCBF and CCPF [Bel ($x > x$) or $Pl(x > x)$] for Power	136
Figure 60: Advanced Turbine Airfoils [126].....	137
Figure 61. Uncertainty Propagation in Technology Valuation for TECH34: Plots of CCBF and CCPF [Bel ($x > x$) or $Pl(x > x)$] for Efficiency.....	138
Figure 62. Uncertainty Propagation in Technology Valuation for TECH34: Plots of CCBF and CCPF [Bel ($x > x$) or $Pl(x > x)$] for Power	138
Figure 63. Uncertainty Propagation in Technology Valuation for Portfolio 1 (TECH07+TECH16): Plots of CCBF and CCPF [Bel ($x > x$) or $Pl(x > x)$] for efficiency	139
Figure 64. Uncertainty Propagation in Technology Valuation for Portfolio 1: Plots of CCBF and CCPF [Bel ($x > x$) or $Pl(x > x)$] for Power	140
Figure 65. Uncertainty Propagation in Technology Valuation for Portfolio 2 (TECH01+TECH07+TECH16+TECH23+TECH34): Plots of CBF and CPF [Bel ($x \leq x$), $Pl(x \leq x)$] for Efficiency	141
Figure 66. Uncertainty Propagation in Technology Valuation for PF2: Plots of CBF and CPF [Bel ($x \leq x$), $Pl(x \leq x)$] for Power.....	142
Figure 67. Uncertainty Propagation in Technology Valuation for Portfolio 2 (TECH01+TECH07+TECH16+TECH23+TECH34): Plots of CCBF and CCPF [Bel ($x > x$) or $Pl(x > x)$] for Efficiency ...	143
Figure 68. Uncertainty Propagation in Technology Valuation for PF2: Plots of CCBF and CCPF [Bel ($x > x$) or $Pl(x > x)$] for Power	143
Figure 69. Uncertainty Propagation in Technology Valuation for PF2: Plots of CCBF and CCPF [Bel ($x > x$) or $Pl(x > x)$] for Efficiency: Comparison between different interval settings	144

Figure 70. Uncertainty Propagation in Technology Valuation for PF2: Plots of CCBF and CCPF [Bel ($x>x$) or Pl($x>x$)] for Power: Comparison between different interval settings.....	145
Figure 71. Uncertainty Associated with margin for Power Improvement.....	147
Figure 72. Uncertainty with Specified Bounds on Power Improvement.....	149
Figure 73. Uncertainty with Specified Bounds on Power Improvement.....	150
Figure 74. Uncertainty with Specified Bounding Interval on Power Improvement.....	151
Figure 75. Technology insertion into program according to TRL timings.....	156
Figure 76: Manufacturing Readiness Levels and their Relationship to Technology Readiness Levels	164

NOMENCLATURE

AAW	active aeroelastic wing
BPA	basic probability assignment
DCF	discounted cash flow
DOE	design of experiments
DR	Dempster's rule
eNPV	expended net present value (from real options)
ET	Evidence Theory
GA	genetic algorithm
GT	gas turbine
HPC	high pressure compressor
HPT	high pressure turbine
IPP	Imprecise Probability Propagation
JTB	Justified True Belief
LPT	low pressure turbine
M&S	modeling and simulation
MADM	multi-attribute decision-making
MC	Monte Carlo
NPV	net present value (from discounted cash flow)
RO	real options
RSE	response surface equation
TCM	technology compatibility matrix
TIF	technology impact factor
TIM	technology impact matrix
TOPSIS	technique for order preference by similarity to ideal solution
TSM	technology synergy matrix
WM	weighted mixing
CBF	Cumulative Belief Function
CPF	Cumulative Plausibility Function
CCBF	Complementary Cumulative Belief Function
CCPF	Complementary Cumulative Plausibility Function

SUMMARY

The management of technology portfolios is an important element of aerospace system design. New technologies are often applied to new product designs to ensure their competitiveness at the time they are introduced to market. The future performance of yet-to-be designed components is inherently uncertain, necessitating subject matter expert knowledge, statistical methods and financial forecasting. Estimates of the appropriate parameter settings often come from disciplinary experts, who may disagree with each other because of varying experience and background. Due to inherent uncertain nature of expert elicitation in technology valuation process, appropriate uncertainty quantification and propagation is very critical. The uncertainty in defining the impact of an input on performance parameters of a system makes it difficult to use traditional probability theory. Often the available information is not enough to assign the appropriate probability distributions to uncertain inputs. Another problem faced during technology elicitation pertains to technology interactions in a portfolio. When multiple technologies are applied simultaneously on a system, often their cumulative impact is non-linear. Current methods assume that technologies are either incompatible or linearly independent.

It is observed that in case of lack of knowledge about the problem, epistemic uncertainty is the most suitable representation of the process. It reduces the number of assumptions during the elicitation process, when experts are forced to assign probability distributions to their opinions without sufficient knowledge. Epistemic uncertainty can be quantified by many techniques. In present research it is proposed that interval analysis and Dempster-Shafer theory of evidence are better suited for quantification of epistemic uncertainty in technology valuation process. Proposed technique seeks to offset some of the problems faced by using deterministic or traditional probabilistic approaches for uncertainty propagation. Non-linear behavior in technology interactions is captured through expert elicitation based technology synergy matrices (TSM). Proposed TSMs

increase the fidelity of current technology forecasting methods by including higher order technology interactions.

A test case for quantification of epistemic uncertainty on a large scale problem of combined cycle power generation system was selected. A detailed multidisciplinary modeling and simulation environment was adopted for this problem. Results have shown that evidence theory based technique provides more insight on the uncertainties arising from incomplete information or lack of knowledge as compared to deterministic or probability theory methods. Margin analysis was also carried out for both the techniques. A detailed description of TSMs and their usage in conjunction with technology impact matrices and technology compatibility matrices is discussed. Various combination methods are also proposed for higher order interactions, which can be applied according to the expert opinion or historical data. The introduction of technology synergy matrix enabled capturing the higher order technology interactions, and improvement in predicted system performance.

CHAPTER 1

UNCERTAINTIES IN KNOWLEDGE ELICITATION

Knowledge elicitation is the foundation for the exploration of new ideas in technological advancements. Subject matter experts can provide a good insight on the impact of technologies on the systems. However the knowledge elicitation for subject matter experts remains a complicated process. If this process is not handled carefully, it can lead to misleading conclusions. Some of these complications arise from involvement of psychological elements such as human experts, facilitators, supervisors etc. [1] Due to human presence in the process of knowledge elicitation, it becomes imperative to take closer attention to various aspects of cognitive psychology and epistemology.

Knowledge and its applications

Types of Knowledge

In real world problems there are many areas where predictive models are used. These models constitute the basis for technology valuation and require a combination of knowledge, information and opinions from the subject matter experts. These elements of predictive models have some distinctive properties and limitations associated with them, which should be considered in their usage.

Knowledge

A branch of philosophy that studies the origin, nature, methods, and limits of human knowledge is called epistemology [2]. Knowledge can be based on evolutionary epistemology using an evolutionary model. Knowledge can be distributed amongst many

branches depending upon the sources [3]. It can be divided in two main types namely nonpropositional and propositional knowledge. Nonpropositional knowledge is further divided into concept, know-how and object knowledge. Concept and know-how knowledge is theoretical, historic or empirical based knowledge on how to conduct a specific activity e.g. riding a bicycle or operating a machine. Object knowledge is also referred as familiarity and deals with the acquaintance to a person, place or any other phenomenon. For example Mr. Smith knows the President of United States [4]. Propositional knowledge is based on certain propositions or claims that can be true or false. It is defined as a branch of knowledge that is based upon propositions that meet the conditions of justified true belief (JTB). Sober (1991) discussed it in detail and provided a framework for propositional knowledge. For example a proposition that “Mr. Smith knows that the Rockies are in North America” can be expressed as:

$$S \text{ knows } P \qquad \text{Equation 1}$$

Where S is the subject and P is the proposition or claim. For this claim to be true, the following conditions must be met[4, 5]:

S must believe P,

P must be true,

S must have a reason to believe P.

In the third condition which is also known as the Justification condition, the reason to believe can come from any source, but in general it should be justified through rational reasoning and empirical evidence. These conditions were established in Plato’s theory of knowledge based on justifiable true believe (JTB). Later they were scrutinized by Gettier’s counterexample [5, 6] that demonstrated that JTB theory breaks down under

specific conditions. It explained that a person can have justified true belief and still be without knowledge. This brought the clear distinction between reliable and infallible evidence. In case of infallible evidence, JTB theory is sufficient for knowledge, but there are very few instances when we have perfect infallible evidence [4]. In general, JTB theory can be accepted for engineering problems [7]. A small doubt in the third condition means that the evidence is not infallible and can be referred as reliable. This phenomenon can be explained through reliability of knowledge.

Various levels of knowledge are discussed below:

- (a) Episteme: the most basic category of cognitive knowledge.
- (b) Dianoia: based on correct reasoning from hypothesis, such as logic and mathematics.
- (c) Pistis: based on belief and intellectual/emotional acceptance of a proposition
- (d) Eikasia: based on inference, theory or prediction originating from incomplete or reliable evidences

The first two categories are intellectual in nature whereas third and fourth categories transition in the realm of appearance and propositions. The pistis and eikasia play a major role in expert opinion elicitation. Although uncertainty is present in these categories, a proper treatment of this uncertainty can offer greater application of the knowledge.

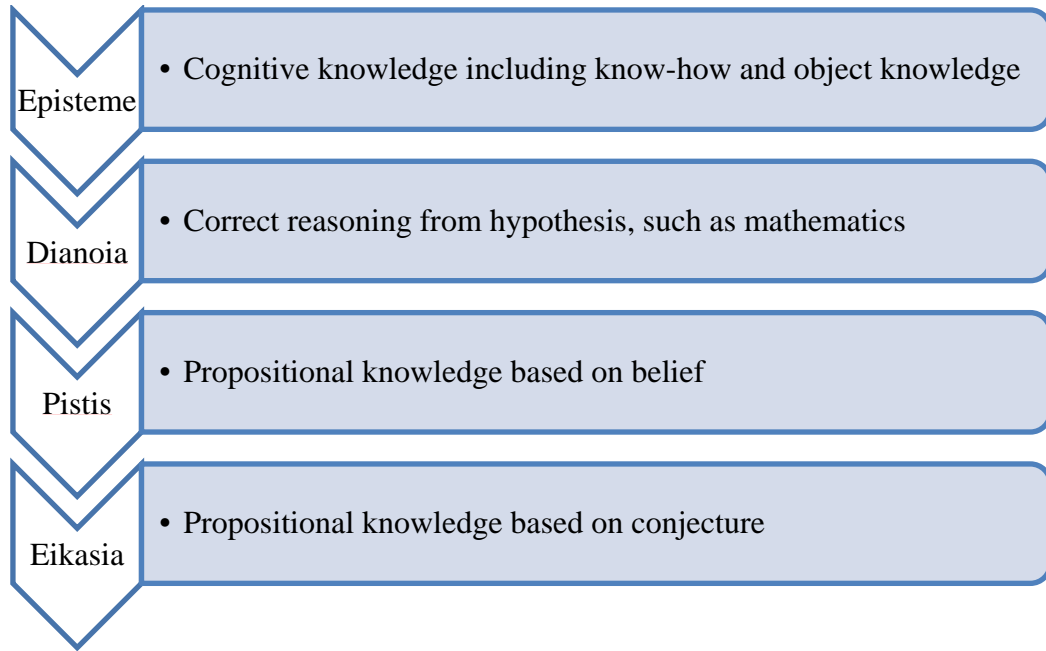

Figure 1: Sources and categories of knowledge [8]

Information

Information is defined as sensed objects, things, places, processes etc. It can also be obtained through communication by language and other multimedia sources [9]. Information and knowledge are closely linked with each other. Unlike some sources who use both these terms as synonym to each other, technically they are not the same. Information is the pre-processed input to cognitive system and forms a basis for knowledge acquisition [9]. Information leads to knowledge through one or more of the following components among others:

- (a) Investigation
- (b) Study
- (c) Reflection

Due to the reliance of knowledge on how human mind reflects, extrapolates and studies the information, using biases and preconceived notions about incoming information and its processing, knowledge is often subjected to uncertainties. JTB theory

makes an effort to this imperfection and evolutionary nature of human behavior. Information might not always lead to evolutionary knowledge, if it does not fulfill the justification condition in JTB. Knowledge attained through information is often accompanied by another important element of ignorance. This area of ignorance has been ignored during early development of theories on human knowledge, but has been gaining attention in recent past.

Opinion

Opinions are processed manifestation of information and knowledge that can be assessed through JTB criteria and not necessarily are infallible. Opinions are elicited from experts, and represent the propositional type of knowledge. These expert opinions may not meet all the conditions of JTB and reliability theory of knowledge; hence they can be proven false or negated by other experts later on. Even with these shortcomings in expert opinions, these are still considered very important element for further growth of knowledge. These opinions aid in expanding the boundaries of current state of knowledge. Use of expert opinion in decision making process needs careful evaluation. Inherent uncertainty, if not captured properly, may lead to undesirable conclusions.

Ignorance

Human mind often put more emphasize on information or knowledge, and intentionally or unintentionally tend to overlook ignorance. This situation may lead to overconfidence. In context of expert elicitation, the determination of the actual knowledge possessed by the expert is a complex phenomenon. The knowledge of an expert about a system has following three aspects.

The actual knowledge possessed by the expert.

The self-perceived knowledge by the expert.

The perception of other people about the expert's knowledge.

It is desirable that all three aspects must be equal to each other. If self-perceived knowledge is more than the actual one, then the difference between these two is the measure of overconfidence [10]. The difference between these areas is also affected by communication skills of the expert. The ignorance of the expert about the actual acquired knowledge can be unintentional or deliberate. During expert elicitation process, this ignorance should be accounted for in order to avoid undesirable results.

Classification of ignorance

The ignorance can be divided into two categories, namely blind ignorance and conscious ignorance. The blind ignorance refers to the type where it is caused by erroneous cognition state and not knowing the information about the system in hand. In this case the person doesn't know about ignorance. Conscious ignorance arises due to deliberate attempt to ignore information due to any reason e.g. due to political conflict, or limited resources [11]. Here the person knows about the ignorance and can take steps to reduce this ignorance. These types can further divided into three categories, namely know-how, object or propositional ignorance as shown in Figure 2. In the field of expert elicitation, uncertainty quantification and propagation, generally the focus is diverted towards conscious ignorance. Reducible aspect of conscious ignorance relates it with epistemic uncertainty. A detailed discussion on reducible uncertainties is done in later sections of this study.

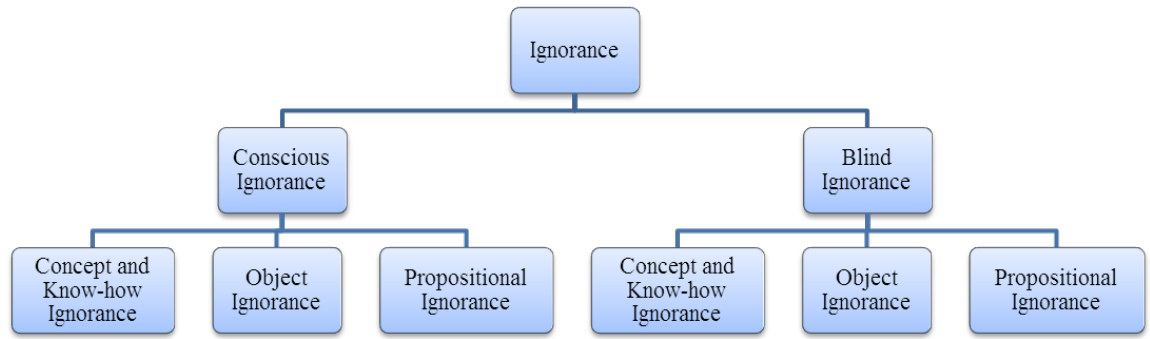

Figure 2. Classification of Ignorance [11]

Expert Elicitation Concepts

Defining an Expert

According to dictionary[2] an expert is “*a person who has special skill or knowledge in some particular field*”. Depending on the nature and requirements of elicitation the expert definition may vary. In certain cases, we might require a person with years of experience and expertise in a specific area to be regarded as expert for elicitation whereas in some other occasion any person from which an opinion is elicited can be described as expert, regardless of their degree of expertise. For every case it is very important to select the most relevant expert to get the meaningful results. In real life problems, many a times the major decisions with huge implications are made in the presence of substantial uncertainty. Characterization and minimization of this uncertainty require genuinely expert judgment. This makes it imperative to decide about experts more critical. Often multiple experts are also involved in the elicitation. This requires an additional layer of combining their opinions into useful analysis.

In addition to knowledge and experience in their respective fields, experts are also distinguished how they organize and use it during elicitation process. Wood and Ford [12] describe the pertinent features of the approach adopted by an expert.

- (a) Expert knowledge is grounded in specific cases
- (b) Experts use formal principles for problem representation
- (c) Experts use known strategies for problem solution
- (d) Experts rely more on procedural knowledge (relationships) and less on declarative one (Facts)

During elicitation process the communication skills of expert are very important. If the expert is fully aware of one's knowledge and know how to accurately represent it then the elicitation can produce meaningful results. On the contrary, if these bounds are not followed in a precise manner, it can produce poor analyses. The knowledge of an expert can be divided into 3 categories.

- (a) An acquired subset of evolutionary infallible knowledge (EIK).
- (b) Self-perceived knowledge.
- (c) Perception by others.

The EIK of the expert should be equal to self-perceived knowledge of an expert. If self-perceived knowledge is more than the acquired EIK of the expert, then the difference represent the overconfidence and psychologically it can be linked to the expert's ego. Similarly another expert of the same area would have different magnitude of these categories that might overlap with the former. These categories make it desirable that experts are able to assess and express their knowledge and related uncertainties well.

Elicitation Methods

Cooke (1991) has discussed some practical guidelines for a successful elicitation process [13]. These guidelines are not restricted to any specific technique and applicable to all methods.

- (a) Clarity in formulation of questions should be adhered. It is very important that all the experts understands and interpret questions correctly to avoid misleading results.

- (b) An appropriate format of questions according to background of experts can greatly expedite the elicitation process. E.g. a graphical representation may be preferred over the written statements. It would also keep the experts engaged for longer durations.
- (c) After selecting the questions and their format, a practice session with smaller number of expert generally results in significant improvements in the elicitation process.
- (d) The analysis of the elicitation process must be performed during the elicitation process. This can address potential issues with interpretation of questions.
- (e) An explanation of elicitation format and treatment of responses by analyst should be explained to participants of elicitation process.
- (f) Analyst should avoid coaching the experts. The explanation of the process should be restricted to dynamics of elicitation only without any bias.
- (g) The elicitation process should be divided into manageable sessions. Experts may lose attention and focus in longer sessions

There are various methods of elicitation based on the type of problem, analyst's priority and experts' familiarity with probabilistic methods.

Indirect:

These methods are used by offering some sort of incentive for experts to bet on an event to express their degree of belief. This was originally introduced by Ramsey [14] and remain popular amongst theoreticians [13]. This technique is not commonly applied to expert probability elicitation. There have been many indirect approaches developed to elicit opinions from experts with no or little knowledge of probability theory. Analysts

have used estimation of time to first failure for equipment as indirect method for estimation of failure probability.

Direct:

As the name suggests, this method rely on direct elicitation from expert. Although it appears very straight forward and convincing, it does have some disadvantages. It can produce very misleading results if expert is not well conversant with the concept of probability. Direct methods were applied through Delphi [15] and nominal group techniques. In Delphi method no interaction is allowed between experts before elicitation whereas in nominal group technique after experts present their opinions, a structured discussion is carried out. After a few iterations the final decision is formulated through mathematical aggregation. Lindley [16] suggested another method where experts are asked to voice their opinion about an occurrence comparing with a selected familiar event [17]. For example an expert is familiar with an event A and its probability of occurrence $p(A)$. The expert is asked to assess the relative probability of another event B to A. This would result in $p(B)=b*p(A)$; where b is the multiplier of $p(A)$ assessed by expert. The probability of B cannot be greater than 1. Some more direct methods are suggested “probability wheel” by De Groot [18], discrete tests and quantile tests [13].

Parametric estimation:

In this technique the confidence interval is measured on the quantities whose distributions are being elicited. This was developed for European space agency in 1989 [19] for the assessment of failure frequencies. Parametric estimation involves 2-step approach.

Step 1: Assessment of median estimate for the probability (M) in question from expert.

Step 2: Assessment of probability (r) that true value will exceed 10 times the median value.

The numbers M and r obtained from these 2 steps represent a unique lognormal distribution and they can be used to compute 5% and 95% confidence bounds as $M/k_{0.95}$ and $M(k_{0.95})$ respectively, where

$$k_{0.95} \approx \left(\frac{\exp(-0.658)}{y_{1-r}} \right)$$

Here y_{1-r} is the $(1-r)^{\text{th}}$ quantile of the standard normal distribution.

Roles in Elicitation Process

During elicitation process there are various distinct roles. Although all these roles are well defined, an individual can assume more than one role during the process. Discussions of advantages and disadvantages of multiple roles would be done later. Following are the roles during elicitation process:

Subject matter expert: It is the individual or a group with relevant knowledge and/or experience about the quantities of interest and associated uncertainties. They are also referred as substantive expert.

Facilitator: The facilitator manages the elicitation process. The responsibilities of the facilitator include presentation of the questions, moderate the dialogue and keep track of the answers offered by subject matter experts.

Analyst/ Statistician: The statistician imparts the probability training to participants of elicitation, provides validation and analysis of results, and presents feedback to the participants. Sometimes they are also referred as normative expert.

Decision Maker: They use the results of elicitation process as an aid to make decisions.

If the facilitator is familiar with statistical approach and analysis then this role can be merged with the role of analyst. Similarly expert's role can be combined with analyst or facilitator, but it has potential of skewed results [20].

Types of Uncertainties in Elicitation

Technology evaluations generally require elicitations from experts about expected improvements in performance or cost related parameters due to technologies in question. This induces an element of uncertainty in the process. Neglecting uncertainties during technology evaluations can result in unexpected outcomes. Uncertainty can be represented in many ways. There have been different theories and studies for this in literature. Identification and application of appropriate representation can lead to better results.

In the past mostly the uncertainties has been represented by probability theory. Although it might be sufficient representation in some cases where we have enough information to correctly capture the uncertainty, in many situations the available information is not enough and we have to use many assumptions to utilize probability theory. Use of these assumptions would lead to inaccurate results. There has been active research in representation of these uncertainties [8, 21, 22]. These theories have shown capabilities with better characterization of uncertainties with limited availability of information.

Classification of Uncertainty

Technology valuation is performed by creating a modeling and simulation environment for representing the system on which technologies are being applied. In this context there may be different sources of uncertainty.

- (a) Uncertainties in the input parameters. For revolutionary technologies, there is a lot of uncertainty in the elicitation from experts.
- (b) Uncertainties in model fidelity and its mathematical robustness. Uncertainties are attached with each phase of model development and application and needs to be characterized as such. Figure 3 represent a view of modeling and simulation by the Society of Computer Simulation [23]. This representation gives an overall process, but misses the uncertainties associated with each phase.

Simulation tool is considered deterministic as it is generally act as the process only and generate the same response for same set of inputs under similar conditions.

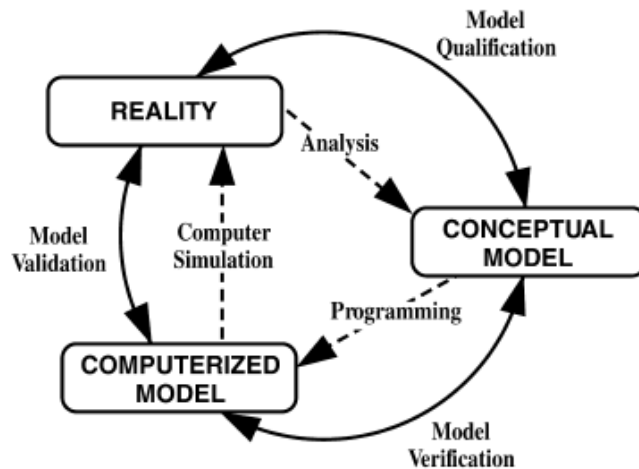

Figure 3. View of modeling and simulation by the Society of Computer Simulation [23]

Uncertainties can be broadly divided into three categories.

- (a) Aleatory Uncertainty
- (b) Epistemic Uncertainty
- (c) Numerical Uncertainty

In technology evaluation and M&S process, all these uncertainties are present either alone or in combination. Total uncertainty is can be estimated by identifying all possible sources of variability, uncertainty and error [24, 25]. It can be observed from Figure 3, that when conceptual/mathematical model is created to represent reality, it incorporates many assumptions, including nonlinearities of physics of the problem, which can be hard to capture completely through a mathematical model. Uncertainties in this phase can be classified as epistemic. When the conceptual model is converted into computer model, there would be uncertainties linked with the fidelity of model. This type can also be characterized by epistemic. Inputs to the computer model can vary from aleatory to epistemic in nature depending on the problem and elicitation area. It is very important to have a good understanding of aleatory and epistemic uncertainty for model inputs and conduct elicitation accordingly to get good results. Computer model also cause numerical errors due to round-off.

Aleatory Uncertainty

Aleatory uncertainty is also referred as inherent uncertainty, irreducible uncertainty, stochastic uncertainty and variability. This type of uncertainty is modeled as random phenomenon and represented by probability distributions. To characterize aleatory uncertainty, sufficient information can be made available such that probability distributions are assigned. To correctly construct probability distributions using relative frequency of occurrence of events, large amount of experimentation is required. If this information is not available, then certain assumption can be made in the form of mean, variance etc. to model the distribution. At times these assumptions are questionable, when they cannot accurately represent physical behavior. In that case epistemic uncertainty can be considered to characterize the phenomenon in a better way. Some examples of aleatory uncertainty are weather and height of individual in population [26] and variation in fatigue life of compressor and turbine blade [27].

Epistemic Uncertainty

Epistemic uncertainty represents lack of knowledge about the quantity in question. It is also known as reducible, subjective or model form or state-of-knowledge uncertainty. Epistemic uncertainty can be reduced by increased understanding and research of the system in question [28, 29]. If some variables have fixed value in a system, then uncertainty about their value can be modeled through epistemic uncertainty based on the level of information about their value. Epistemic uncertainty can show-up in many forms including parametric and model form.

Parametric Uncertainty

This is the form of uncertainty, where information relating to uncertain variable is incomplete or inadequate. In this case the uncertainty in parameters is propagated to outcomes of the system. It can be modeled in number of ways including interval analysis, evidence theory and second-order probability.

Model form Uncertainty

This uncertainty is linked to the fidelity of analysis model. Models representing different fidelities would generate different results. This type of uncertainty exists when there is little to none knowledge exists to create a model of physical phenomenon. It can arise from different forms:

- (a) Selection of different fidelity models
- (b) Lack of information to simulate conditions
- (c) Lack of unified modeling technique

An example of model form uncertainty can be seen during decision for employing laminar and turbulent flows in a fluid mechanics example.

Numerical Uncertainty

It is generally referred as error. Numerical uncertainty can appear from round-off errors, truncation errors, convergence related issues etc. in modeling and simulation environment.

Uncertainty Modeling and propagation

Uncertainty can be modeled and propagated in number of ways. Some of them include probability theory, the theory of fuzzy sets[75], Dempster-Shafer theory[22], possibility theory[18], interval analysis [71], second order probability and convex model of uncertainty. Some of these theories only deal with epistemic uncertainty; most deal with both. Few of these theories are discussed briefly in following paragraphs.

Probability Theory

Probability theory is generally employed if enough data is available, so that the probability distribution can be correctly modeled. It represents the uncertainty in random variables. These random variables can be discrete or continuous. Different approaches have been used within probability theory domain including the classical, the frequentist, and the subjectivist or Bayesian [30-32].

In case of continuous variables probability density function (PDF) describes relative likelihood of an occurrence to happen at a given point. It represents the nature of randomness and information on probability. The probability of the random variable “X” to have a value between two realizations of x_1 and x_2 is expressed as following:

$$P(x_1 < X \leq x_2) = \int_{x_1}^{x_2} f_x(x) dx \quad \text{Equation 2}$$

Cumulative distribution function (CDF) represents the probability of a random variable “X” to be found less than or equal to a number x.

$$F_x(x) = P(X \leq x) = \int_{-\infty}^x f_x(x) dx \quad \text{Equation 3}$$

For CDF the area under PDF is integrated for all possible values of X less than or equal to x. The PDF and the CDF are related to each other through derivation. The PDF is the first derivative of CDF.

$$f_x(x) = \frac{dF_x(x)}{dx} \quad \text{Equation 4}$$

Similarly mean (μ), standard deviation (σ) and correlation between random variables X_1 and X_2 (ρ_{12}) can be expressed as:

$$\mu = \int_{-\infty}^{\infty} x f_x(x) dx \quad \text{Equation 5}$$

$$\sigma^2 = \int_{-\infty}^{\infty} (x - \mu)^2 f_x(x) dx \quad \text{Equation 6}$$

$$\rho_{12}\sigma_1\sigma_2 = \iint_{-\infty}^{\infty} (x_1 - \mu_1)(x_2 - \mu_2) f_{x_1, x_2}(x_1, x_2) dx_1 dx_2 \quad \text{Equation 7}$$

Here $f_{x_1, x_2}(x_1, x_2)$ represent the joint probability density function of X_1 and X_2 . Similarly statistical quantities can also be represented for a scalar function $g(X_1, X_2, \dots, X_n)$. The mean value of g is shown below:

$$\mu_g = \int_{-\infty}^{\infty} g(x_1, x_2, \dots, x_n) f_{x_1, x_2, \dots, x_n}(x_1, x_2, \dots, x_n) dx_1 dx_2 \dots dx_n \quad \text{Equation 8}$$

Bayesian probability is another approach used for application of probability theory. Bayesian method incorporates the scientific hypothesis in the analysis by introducing prior distributions. It interprets probability as a rational agent's degree of belief about an uncertain event. If the hypothesis of the agent is found not to be true, then previously calculated probability is updated. Statistical inference is taken as the modification of uncertainty about the value of the parameter according to evidence. Bayes' theorem is utilized to model this modification [32, 33].

Fuzzy Sets

In case of sparse data, fuzzy set theory can be used to model uncertainties [34]. In classical sets, fixed boundaries are used to determine that an element belongs to the set or otherwise. These are also called crisp sets. In fuzzy sets this condition of fixed boundaries is not required. Fuzzy sets utilize the partial membership functions to decide whether an

element belongs to a set [35]. These functions are usually expressed as unit interval of real numbers from 0 to 1. In this interval 0 refers to no compatibility of the element to a particular set whereas 1 refers to highest level of compatibility [36]. Membership function is expressed as following:

$$\alpha_A(x): X \rightarrow [0,1] \quad \text{Equation 9}$$

Where X is a universal set and membership function $\alpha_A(x)$ is the level of compatibility of x in A. For membership function different shapes can be assumed. A triangle membership function can be defined as follows:

$$A = [a, b, c] \quad \text{Equation 10}$$

In Equation 12, a and c represent the lower and upper points in triangular membership function at $\alpha=0$ and b represent the x value at $\alpha=1$. Similarly other shapes of membership functions, such as trapezoidal and bell, can be applied.

Interval analysis

Interval analysis technique is used when there is no other information is available, except that input variables lie within a certain interval. This is a simple and straight forward approach to handle epistemic uncertainties. The upper and lower values of output variables are calculated by utilizing appropriate optimization techniques such as bound constrained Newton methods [26]. These methods provide upper and lower bounds on the output. This approach to interval analysis can be very expensive if the model is very nonlinear with respect to inputs. To find the global optima, global methods are required to be used which can be very computationally expensive. A way to handle this drawback

is using the surrogate model [37] through the use of samples. A high fidelity modeling and simulation environment can take considerably long time to translate the impact of input variables on outputs. A surrogate model is a fast executing regression of modeling code behavior and replaces the computationally expensive modeling and simulation environment. A surrogate model would enable fast execution of analysis to quickly obtain the bounds on output. Surrogate based optimization methods are also used to get the output intervals.

Another method to implement interval analysis utilizes the sampling from the input variables. The lower and upper bounds on outputs are obtained from these samples. The accuracy of this approach is highly dependent on number of samples and generally underestimates the actual output interval [26].

Second Order probability

In engineering applications, sometimes the problem involves both aleatory and epistemic uncertainties. Second order probability addresses this kind of uncertainties [26]. It can propagate both type of uncertainty. It can be seen in a situation where a designer may know about the form of probability distribution of an uncertain variable, but there is a lack of knowledge about the values of the parameters that govern the distribution. This problem is addressed by utilizing two loops. Aleatory uncertainty is handled in inner loop whereas epistemic uncertainty is kept on the outer loop as shown in Figure 4. In outer loop the epistemic uncertainty is applied on the uncertain variables in the form of intervals. A particular value from these intervals is selected to be passed on to inner loop. In the inner loop, the sampling is done for aleatory uncertainty for the selected realization of epistemic uncertain values. This results in generation of a series of CDF's, one each for a particular value of a parameter from outer loop.

Sometimes, it can be prohibitively expensive as sampling is performed in two loops, but it can be very useful when distinction between aleatory and epistemic uncertainties can provide better results. Second-order probability has been applied in extensively in nuclear waste and safety assessments [29, 38].

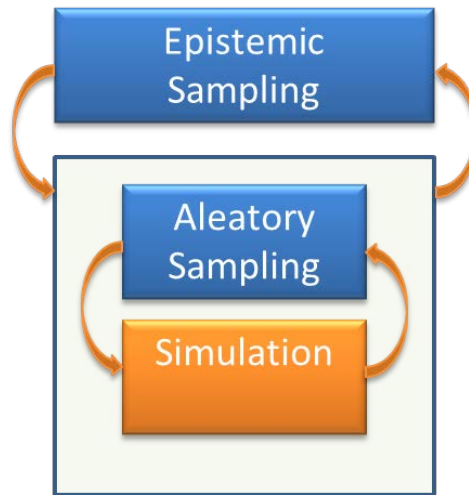

Figure 4. Second-order Probability [26]

Possibility theory

Possibility theory can be applied when the information about variables is insufficient. This theory provides uncertainty representation that permits the specifications of more structure than interval analysis [34, 39]. Variable x_i is specified as a pair (X_i, r_i) also known as possibility space for the variable x_i . Here X_i represents the universal set that contains all possible values of x_i . The function r_i is called the possibility distribution of x_i and is defined on X_i such that :

$$0 \leq r_i(x_i) \leq 1 \quad \text{for } x_i \in X_i$$

and

$$\sup\{r_i(x_i): x_i \in X_i\} = 1$$

The value of $r_i(x_i) = 0$ means that the information completely refutes the value of occurrence of x_i where as $r_i(x_i) = 1$ suggests that there is no known information that refutes the occurrence of x_i .

Possibility theory has distinct differences from probability theory. Some of the difference can be noted from the following axioms of possibility theory. If Θ is a finite universal set then distribution of possibility is a function pos such that:

$$\text{pos}(\emptyset) = 0$$

$$\text{pos}(\Theta) = 1$$

$$\text{pos}(A \cup B) = \max(\text{pos}(A), \text{pos}(B)) \text{ for any subsets } A \text{ and } B$$

$$\text{pos}(A \cap B) \leq \min(\text{pos}(A), \text{pos}(B)) \text{ for any subsets } A \text{ and } B$$

The other metric used by possibility theory is necessity (nec) function. It is defined as:

$$\text{nec}(A) = 1 - \text{pos}(\bar{A})$$

whereas \bar{A} represents the complement of A for universal set Θ .

Convex Model of Uncertainty

In case the uncertain events form some sort of patterns, convex models can be utilized for their modeling [40, 41]. Convex models require less information as compared to probability theory for the characterization of uncertainty. These patterns can be ellipses, intervals, or any other type of convex sets. It is generally handled by constrained optimization techniques and requires worst case analysis. Based on complexity of the problem, local or global optimizations can be utilized.

Info-Gap Theory

Information-gap is utilized when severe lack of knowledge exists [42]. Unlike probability theory, info-gap theory does not use distributions to quantify lack of knowledge [43]. This theory works well when the available information is very scarce. In case more information is available, then probabilistic or fuzzy logic based approach becomes more relevant. This theory has been used in various fields where different explanations of uncertainty and its propagation were introduced. Galbraith [44] used it for design of complex organizations and defines uncertainty as information gap between the amount of knowledge required to perform a specific task and available information. Laufer [45] discussed project management and emphasized that in today's world of uncertainty it is not how early the decision can be made, rather the ability to reduce the impact of uncertainty and to minimize the element of surprise become more important.

Info-gap modeling needs to be problem specific as discussed by Keith and Ben-Haim [46] for waste management study. A simple info-gap model was constructed for waste management problem:

$$U(\alpha, \tilde{r}) = \{r(x, t, w) : |r(x, t, w) - \tilde{r}(x, t, w)| \leq \alpha\}, \alpha \geq 0 \quad \text{Equation 11}$$

Where $\tilde{r}(x, t, w)$ is a removal rate and is function of position (x), time (t) and a general variable (w), which depends on the available model. The actual function $r(x, t, w)$ varies from nominal function $\tilde{r}(x, t, w)$ in an uncertain manner. No information is available about the likelihood of alternate rate functions. This lack of information makes this problem unsuitable for probability theory and theory of fuzzy sets. If theory of fuzzy sets is applied in this problem, many unverified assumption would be required to be made. α represent the uncertainty parameter. The deviation of $U(\alpha, \tilde{r})$ needs to be lower than α . Larger values of α represent greater range of unknown variation. In many cases,

the value of α is unknown too, requiring a creation of a family of nested sets. This combination of nested sets is referred as information-gap model of uncertainty.

Dempster-Shafer Theory of Evidence

Dempster-Shafer theory of evidence is a useful technique for quantification of epistemic uncertainty. It is a non-intrusive method where the modeling and simulation environment remains a black box for uncertainty quantification purposes. Another advantage of this theory is that it uses the calculations from probabilistic framework, which are commonly available [28]. When the information about a problem is non-specific, ambiguous, or conflicting, this theory relaxes the assumptions of probability theory [26]. This particular aspect increases the utility of Dempster-Shafer theory in technology valuation process, as generally the amount of information on performance impact of technologies under development is limited. This theory is also capable of accounting for evidence that can be assigned to multiple events, as opposed to probability theory where evidence is associated with only one possible event. The term evidence expresses the information obtained from either observation or experimentation [47]. This information is generally imprecise or uncertain when discussed from the perspective of evidence theory. Dempster-Shafer theory can also account for conflicting evidence by assigning different belief functions based on the compatibility or otherwise amongst multiple sources of evidence.

The input uncertain variables are modeled as sets of intervals. These variables can be assigned one or more intervals. In case of multiple intervals, each interval is assigned a unique basic probability assignment (BPA). BPA indicates the likelihood of the occurrence of the input to fall in that interval. The sum of BPAs of a particular variable must be equal to one. Within one interval, there is an equal likelihood of the event to occur. The intervals can be adjacent, disjoint or overlapping as shown in Figure 5. In the

figure a BPA of 0.6 is assigned to values of an uncertain variable from 0.96 to 0.98. Similarly a BPA of 0.4 is assigned for an interval from 0.98 to 1.1. An example of disjoint and overlapping intervals is also shown in Figure 5.



(a) Adjacent Intervals

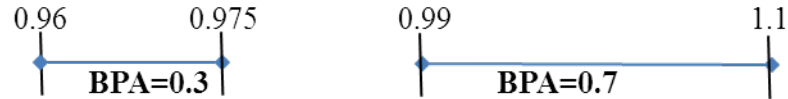

(b) Disjoint Intervals

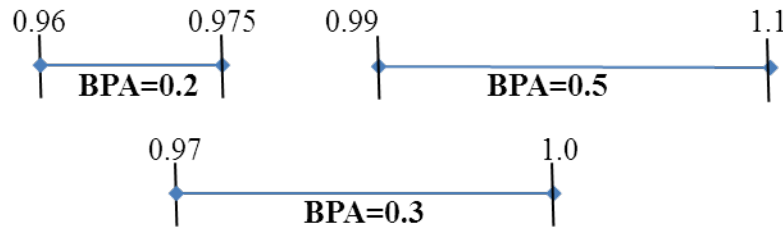

(c) Overlapping Intervals

Figure 5: Intervals for uncertain variables and their associated BPAs

Dempster-Shafer theory is formulated in terms of the function say m , that maps the power set of a universal set Θ to $[0,1]$. Θ is assumed to be a finite, non-empty set and is also called frame of discernment. This power set ($P(\Theta)$ or 2^Θ) represents all possible subsets of the universal subset of Θ .

$$m : 2^\Theta \rightarrow [0,1] \quad \text{Equation 12}$$

Such that

$$(a) \quad 0 \leq m(A) \leq 1 \quad \text{for any } A \in 2^\Theta$$

$$(b) \quad m(\emptyset) = 0$$

$$(c) \quad \sum_{A \subseteq \Theta} m(A) = 1$$

This function m is called basic probability assignment [48]. A is an event which is subset of Θ . $m(A)$ represents the evidential support or BPA corresponding to event A , but not to any specific subset of A . All subsets A of Θ ($A \in 2^\Theta$) for which $m(A) \neq 0$, are called focal elements. If F represents the set of all focal elements of m , then the pair (F, m) is called a body of evidence.

Dempster-Shafer theory of evidence uses belief and plausibility as two measures of uncertainty. The intervals of uncertain variables are used to calculate the belief and plausibility. Belief represents a lower bound on a probability value that is consistent with the evidence. In other words it represents the minimum amount of absolute confidence that an event will occur whereas plausibility is the upper bound consistent with the given evidence. Belief and plausibility are determined for all sets $A \in 2^\Theta$ by following equations:

$$Bel(A) = \sum_{B \subseteq A} m(B) \quad \text{Equation 13}$$

$$Pl(A) = \sum_{B \cap A \neq \emptyset} m(B) \quad \text{Equation 14}$$

It can be observed that $Bel(A)$ is calculated by summation of all BPAs of the evidences that totally agree with the event A whereas $Pl(A)$ is calculated by all the BPAs of the evidences that totally and partially agree with event A .

Due to presence of uncertainty the evidential measure of an event to occur and its complement does not have to be equal to one, as shown in Figure 6. \bar{A} represent the negation of an event A .

$$Bel(A) + Bel(\bar{A}) \leq 1 \quad \text{for all } A \subseteq \Theta \quad \text{Equation 15}$$

Also from Figure 6, plausibility (Pl) can be expressed as following:

$$Pl(A) = 1 - Bel(\bar{A}) \quad \text{Equation 16}$$

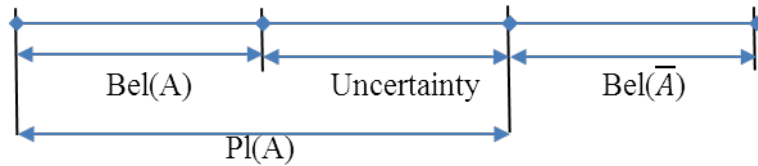

Figure 6: Belief and plausibility in evidence theory [49]

This uncertainty is also referred as ignorance in literature [50]. From Equation 15 and Equation 16, it can be inferred that

$$Bel(A) \leq Pl(A)$$

For a subset “ A ” of Θ , the information available through evidential function $Bel(A)$ and $Pl(A)$ can be represented by belief interval $[Bel(A), Pl(A)]$. $Bel(A)$ represent the degree to which evidence absolutely supports the subset A and $Pl(A)$ represent the degree to which the evidence remain plausible. The residual uncertainty (ignorance) is then defined by following equation:

$$ignorance(A) = Pl(A) - Bel(A)$$

Equation 17

Hence Equation 17 suggests that Dempster-Shafer theory of evidence takes into account what is known as well as the unknown or uncertain part of information. This makes the use of this theory very desirable in case of epistemic uncertainties.

Belief function can be defined as following:

$$Bel : 2^\Theta \rightarrow [0,1]$$

If it satisfies following

$$Bel(\emptyset) = 0$$

$$Bel(\Theta) = 1$$

For any collection A_1, A_2, \dots, A_n ($n \geq 1$) of subsets of Θ

$$Bel(A_1 \cup A_2 \cup \dots \cup A_n) \geq \sum_{I \subseteq \{1,2,\dots,n\}, I \neq \emptyset} (-1)^{|I|+1} bel(\cap_{i \in I} A_i)$$

$$Bel(A) = \sum_{X \subseteq \Theta} m(B) \text{ for all } A \subseteq \Theta$$

$$0 \leq Bel(A) \leq 1 \text{ for all } A \subseteq \Theta$$

$$Bel(A) \geq 0 \text{ for all } A \subseteq \Theta$$

Inversion between BPA and belief function is defined as follows:

$$m(A) = \sum_{B \subseteq \Theta} (-1)^{|A-B|} Bel(B) \text{ for all } A \subseteq \Theta$$

$$Bel(A) = \sum_{X \subseteq A} m(B) \text{ for all } A \subseteq \Theta$$

Here $|A - B|$ represent the difference in cardinality of sets A and X. For each belief function only and only one mass function corresponds and vice versa[50].

Similarly plausibility function show following characteristics:

$$pls(A) = 1 - bel(\bar{A}) \text{ for all } A \subseteq \theta$$

$$bel(A) = 1 - pls(\bar{A}) \text{ for all } A \subseteq \theta$$

$$Pl(\emptyset) = 0$$

$$Pl(\theta) = 1$$

Combination of evidence

Aggregation of information is used to meaningfully compiling and simplifying the data from a single or multiple sources. Generally it is done by arithmetic averages, geometric averages, harmonic averages, minimum and maximum values [17]. Combination rules are special cases of evidence. These rules aggregate the information gathered from multiple sources for same frame of discernment. These sources provide different assessments.

There are different rules that can be used for combination of evidence. Sentz and Ferson [51] discussed these methods in detail in their report. These rules include the Dempster rule of combination, Yager's modified Dempster rule, Inagaki's unified combination rule, Zhang's center combination rule, Dubois and Prade's disjunctive consensus rule, Discount and combine method, Convolutional Averaging, and Mixing or averaging. They apply on different situations and many of these rules are formulated on the basis of Dempster's rule of combination and offer modifications in Dempster's rule.

Dempster's rule of combination:

Dempster's rule of combination applies to multiple evidences which are independent but belong to same set of discernment. This set of belief functions are combined with Dempster rule as shown in Equation 18.

$$m_{12}(A) = \frac{\sum_{B \cap C = A} m_1(B)m_2(C)}{1 - K}, A \neq \emptyset \quad \text{Equation 18}$$

Assuming

$$m_{12}(\emptyset) \neq 0 \quad \text{Equation 19}$$

Where

$$K = \sum_{B \cap C = \emptyset} m_1(B)m_2(C) \quad \text{Equation 20}$$

K is calculated by summation of the products of the BPAs where intersection between evidence is null. The denominator in Equation 18 is a normalization factor, which ignores all the conflicts. In case of significant conflicts in evidence, this rule can yield some unexpected results.

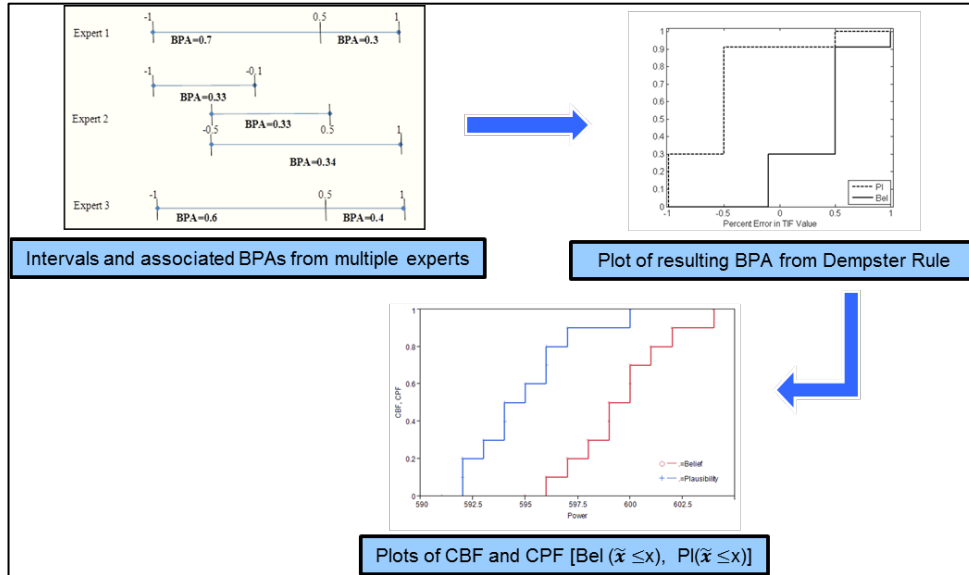

Figure 7: Aggregation of Evidence from Multiple Experts

Dempster-Shafer theory assumes that these sources are independent. The use of Dempster rule of combination is criticized for the situations when significant conflicts in evidence are encountered. These conflicts need to be addressed prior to applying the Dempster rule. If there are no significant conflicts, Dempster’s rule provide reliable results. In present study, filters are applied during elicitation process to resolve such conflicts before applying combination rules.

To demonstrate the basic calculations for Dempster’s rule of combination, an example is presented in Table 1. In this example two experts are offering their knowledge about three events namely A, B and C. The Expert 1 believes that associated probabilities for these events to happen are $m_1(A)$, $m_1(B)$ and $m_1(C)$ respectively whereas Expert 2 believe them to be $m_2(A)$, $m_2(B)$ and $m_2(C)$. The basic probability assignments (BPAs) are combined as shown in the table. Finally the joint probability is obtained from Equation 18 through Equation 20 with the help of Table 1.

Table 1: Calculations for Dempster’s rule of Combination (Two Experts)

		Expert 2			
		Event >>	A	B	C
Expert 1	Event	BPA	$m_2(A)$	$m_2(B)$	$m_2(C)$
	A	$m_1(A)$	$m_1(A)m_2(A)$	$m_1(A)m_2(B)$	$m_1(A)m_2(C)$
	B	$m_1(B)$	$m_1(B)m_2(A)$	$m_1(B)m_2(B)$	$m_1(B)m_2(C)$
	C	$m_1(C)$	$m_1(C)m_2(A)$	$m_1(C)m_2(B)$	$m_1(C)m_2(C)$

The outcome of this method is an interval-valued probability distribution. The notional resulting cumulative belief and plausibility functions from Dempster-Shafer theory are shown in Figure 8 [26]. In Dempster-Shafer theory, cumulative belief function is similar to cumulative distribution function in probability theory. It represents that the value of uncertain variable y^* is less than the given value y . It is often denoted by $Bel(y^* \leq y)$. Similarly plausibility can be denoted by $Pl(y^* \leq y)$. From Figure 8, it can be explained that the cumulative belief that shear mode frequency is less than or equal to 2200 Hz is 0.35, whereas cumulative plausibility is it is less than 0.8 for the same frequency. The step function like behavior is due to intervals assignment to inputs.

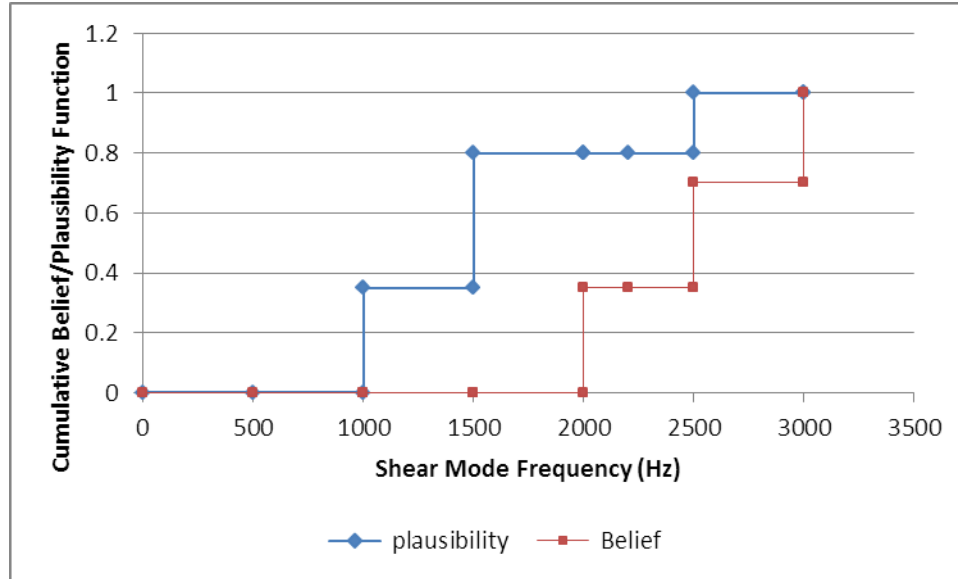

Figure 8: Dempster-Shafer Analysis of Shear Mode Frequency

Yager’s modified Dempster rule:

Yager presented a modification in Dempster rule while addressing the issue of normalization [52, 53]. He presented the concept of ground probability mass distribution in addition to basic probability mass distribution which was initially used in Dempster rule of combination. The ground probability mass distribution carries no normalization factor. It is defined in Equation 21.

$$q(A) = \sum_{B \cap C = A} m_1(B)m_2(C) \quad \text{Equation 21}$$

Where $q(A)$ denotes the ground probability assignment. B and C are members of a power set $P(X)$ and A is the intersection of B and C . m represents the basic probability mass assignment. It is emphasized by Yager that combination rules should be able to update once new information becomes available. It is possible through the property

referred as associativity. Another aspect of Yager rule of combination is its ability to use any number of evidence. It is shown in Equation 22.

$$q(A) = \sum_{\cap_{i=1}^n A_i = A} m_1(A_1)m_2(A_2)m_3(A_3) \dots m_n(A_n) \quad \text{Equation 22}$$

Here m_i represents the basic probability assignment associated with i^{th} believe structure. In Equation 22, $q(A)$ denotes the combination of multiple basic probability assignments.

Dempster rule address the conflict by normalization whereas Yager rule of combination does not modify the evidence in case of conflict rather it treats in such a manner that I causes the degree of ignorance to increase. Yager rule of combination is also known as modified Dempster's Rule.

Inagaki's unified combination rule:

Inagaki introduced the combination rule by modifying the Dempster's and Yager's rules. Inagaki used Yager's ground probability assignment function and build a new class of combination operators [54]. He asserted that there is no credibility or reliability of the sources of knowledge. This assumption sometimes restricts the use of this rule. Inagaki's rule of combination maintains the strict relationship between basic probability mass assignment (m) and ground probability assignment (q).

$$\frac{m(A)}{m(B)} = \frac{q(A)}{q(B)} \quad \text{Equation 23}$$

Inagaki defines the rule of combination as:

$$m(A) = q(A) + f(A)q(\emptyset) \quad \text{Equation 24}$$

Where $f(A)$ is the scaling function for $q(\emptyset)$ and is always equal or greater than zero where $A \neq \emptyset$.

Also

$$\sum_{A \subset X, A \neq \emptyset} f(A) = 1 \quad \text{Equation 25}$$

Inagaki's rule handles the conflict in evidence by filtering the evidence. The magnitude of the filtration is a complex problem and involves the determination process of conflict (k) and ground probability distribution. Inagaki's rule can be compared with the Yager's rule, where the evidence is not changed and conflict is assigned to the universal set. In case of Dempster's rule the conflict is ignored and the evidence is filtered.

Zhang's center combination rule

Zhang's rule of combination [55] provides another alternative to Dempster's rule. This rule provides interpretation of Dempster's rule with two frames of discernment. Zhang assumes two frames of discernment and explains that the compatibility relation between them can be used as a basis for provision of truth in one frame with the help of the other frame of discernment. The belief function for an event B can be represented as following:

$$Bel(B) = P\{x|x \in X \text{ and } \exists y \in B \text{ s. t. } (x, y) \in D\} \quad \text{Equation 26}$$

Where x and y denotes the elements of X and Y respectively. X and Y represent two frames of discernments and D is the compatibility relation between them. Equation 26 represents the probability about the available evidence in X , which can provide the information in Y through the compatibility relation D . Zhang also mentioned that Dempster's rule of combination failed to include intersection of focal points. He introduced an additional relationship based on cardinality of individual sets in Dempster's rule.

$$m_{12}(A) = k \sum_{B \cap C = A} \left[\frac{|A|}{|B||C|} m_1(B)m_2(C) \right] \quad \text{Equation 27}$$

Here k is a renormalization factor and independent of A , m_1 and m_2 . $|B|$ and $|C|$ represent the cardinality of B and C , and $B \cap C = A$. If $|B||C| = |A|$, then Equation 27 represents the Dempster's rule.

Dubois and Prade's disjunctive consensus rule

Dubois and Prade [56, 57] based their approach on set theory. They used the union of basic probability assignments such that no information is rejected neither any conflict is generated as a result of application of this rule.

$$m_{\cup}(A) = \sum_{B \cup C = A} [m_1(B)m_2(C)] \quad \text{Equation 28}$$

Where $m_{\cup}(A)$ represent union of basic probability assignments $m_1 \cup m_2$. Although this rule removes any necessity of normalization factor, in many occasions it can generate excessively imprecise results.

Discount and combine method

This method takes into account the reliability of the sources of information. It was initially proposed by Shafer [58]. Each source is assigned a degree of trust before the combination and then an averaged function is used. First a discounting factor α is assigned to each belief and represented by following equation:

$$Bel^{\alpha_i}(A) = (1 - \alpha_i)Bel(A) \quad \text{Equation 29}$$

Where $Bel^{\alpha_i}(A)$ is a discounting function and $(1-\alpha_i)$ represents the degree of trust.

Also

$$0 \leq \alpha_i \leq 1$$

Finally

$$\overline{Bel}(A) = \frac{1}{n} [Bel^{\alpha_1}(A) + Bel^{\alpha_2}(A) + \dots + Bel^{\alpha_n}(A)] \quad \text{Equation 30}$$

Where $\overline{Bel}(A)$ represent the average of all discounted belief functions. It can also be deduced from Equation 30 that in case a strong conflict is observed by one belief function, whereas other belief functions are closer to each other, then the effect of the function with a conflict will be reduced. It is also emphasized that assigning the degree of trust require a lot of knowledge about all sources of belief in order to get the meaningful results.

Mixing or averaging

This method applies weights on basic probability assignments before taking their averages [59]. It can be observed that this method is similar to discount and combine method, the only difference is that in discount and combine method the weights are applied on beliefs whereas in mixing method they are applied on basic probability distributions.

$$m_{1\dots n}(A) = \frac{1}{n} \sum_{i=1}^n [w_i m_i(A)] \quad \text{Equation 31}$$

Where w_i are the weights assigned to each basic probability assignment ($m_i(A)$) according to the degree of trust.

Ferson and Kreinovich [59] also offered convolutive x-averaging method. In this method the Dempster-Shafer structures are treated as scalar numbers and their average is taken as shown in Equation 32.

$$m_{1\dots n}(A) = \frac{1}{\sum A_i} \prod_{i=1}^n [w_i m_i(A)] \quad \text{Equation 32}$$

In Equation 32, w_i represent the weights assigned according to the degree of trust.

Margin Analysis

Margin analysis translates input uncertainties to structures of margins. There are different ways to analyze margins depending upon the propagation methods of aleatory and epistemic uncertainties [60, 61]. It is a measure of the difference between performance requirements of the system (R) and actual achieved performance(P) of the system [61].

$$M(R, P|e) = R - P \quad \text{Equation 33}$$

Where M represents the margin, e is the vector of epistemic uncertain parameters. In case $M \geq 0$, it means that requirement is met, whereas $M < 0$ shows that requirement is not met. The margins, when analyzed under uncertainty are themselves uncertain. Their uncertainty originates from the uncertainty attached with the input variables. The margins can also be specified in terms of intervals to incorporate uncertainty.

In case of Dempster-Shafer representation of uncertainty in Figure 8, if requirement is set to 3000 Hz, it can be observed that both cumulative belief and plausibility values are 1.

$$P_{3000} = \{\tilde{P}: \tilde{P} \in P, \tilde{P} \leq 3000\}$$

This means that measure that performance set P can be met is given by:

$$[Bel_P(P_{3000}), Pl_P(P_{3000})] = [1.0, 1.0]$$

Here $Bel_P(P_{3000})$ is the measure of the information that supports the proposition that the value of shear mode frequency is contained in P_{3000} , whereas $Pl_P(P_{3000})$ refers to the information that does not refute the proposition that the value of shear mode frequency is contained in P_{3000} . Both belief and plausibility shows that margin would be satisfied. In the same example if the requirement is set to 2700 Hz, it would be represented as following:

$$[Bel_P(P_{2700}), Pl_P(P_{2700})] = [0.7, 1.0]$$

Hence we it would transforms to $Bel_P(\bar{P}_{2700}) = 0.3$, where \bar{P} represent the negation of event P. This implies that there is evidence that the shear mode frequency does not fall within 2700 Hz. In this case belief infers that there is 30 percent chance that margin is not met. For decision making, results should not be reduced to margin analysis. Helton [61] suggests that cumulative belief and plausibility plots should be taken into account with requirements shown as a constraints.

CHAPTER 2

EXPERT ELICITATION PROCESS

There are some good practices as discussed by many previous studies [62-66]. These studies differ in details of the steps involved in elicitation process but broadly agree on following five steps:

Preparation background

Elicitation process is started with the selection of appropriate variables of interest. This selection can become complicated, if the problem in hand is complex. A bad selection of variables can make whole elicitation process useless. Another important element of this step is application of suitable statistical methods for elicitation. Well-chosen statistical methods would help get the desired format of the process. Selection of variables and statistical methods should be prepared by the client or decision maker with facilitator or analyst. The combined preparation would also give a good insight to the facilitator, who gets basic knowledge and understanding of the problem. This also helps facilitator discuss the problem with experts in a better way. The facilitator also plan for the session handling in this step involving preparation of questionnaire, background for experts and transcript of problem definition.

Expert recruitment

Elicitation process heavily depends on experts, so their selection from the pool of individuals helps gain better results. Sometimes the selection can be very simple or obvious depending on the nature and scope of the problem, but at times it may be required to follow the more open and rigorous approach. If the elicitation is done for

some issue of huge public interest, like handling of nuclear waste [67], the process needs to be transparent as there are many stake holders in the problem and any perceived or actual bias may raise questions about validity of the process. Familiarity of expert with statistical methods can be considered too, as this would help the expert easily transform the acquired knowledge into the required elicitation. A training of experts for statistical and probability concepts can also be conducted before actual elicitation takes place. Training is discussed in next step. Hora and von Winterfeldt [67] suggested six conditions for an expert:

- (a) Tangible evidence of expertise
- (b) Reputation
- (c) Availability and willingness to attend elicitation sessions
- (d) Understanding of the specific problem dynamics
- (e) Impartiality
- (f) No economic or personal conflict of interest with the potential outcome of elicitation process

Sometimes it is not possible to have expert with impartiality and no conflict of interest. In that case, the conflict of interest should be recorded in elicitation proceedings.

Expert training

Before elicitation session a detailed description of problem, elicitation process and utilization of results should be given to experts. It helps experts get familiarized with the process and articulate their responses accordingly. Sometimes experts are not very comfortable with probabilities and uncertainties. Clemen and Reilly [62] suggested discussing the issue of uncertainty with experts and explaining that uncertainties in their responses would be captured during the elicitation process. In an elicitation study, Walker et al. (pp30-hogan) also observed that experts were particularly uncomfortable with

probabilistic nature of elicited distributions. This problem can be addressed to an extent by offering appropriate training. This training should include following elements:

- (a) Uncertainty and probabilities.
- (b) Commonly observed pitfalls/ biases during elicitation process and ways to overcome them.
- (c) Practice elicitations on known issues.

During the training session, the facilitator/statistician should try to impart working statistical knowledge to expert, while avoiding to influence their responses in elicitation process.

Structuring the elicitation

There should be a good portion of time reserved to finalize the structure of elicitation process. All the possible dependencies, sensitivities and relevant impacts should be considered [68]. This step is generally done by client and statistician, but the input of expert is very vital here. Expert would be able to give further insight about quantities of interest and may suggest changes in the structure itself. The quantities, for which elicitation is required, should be defined precisely. The questions that are finalized to be asked need to be clear. If ambiguity exist in the questions, it would be difficult to retain the focus of the expert in elicitation process. Experts are likely to lose their interest in the process, if they feel that analyst does not know about the subjects and the questions are not aligned with the scope of the elicitation. The questions should be as direct as possible with clear definition and details about the background.

Elicitation

This is the step where actual response from experts is elicited and recorded. This is an iterative process where elicitation is done from experts either deterministically or probabilistically. Probability distributions are combined and feedback sought in case of noticeable conflict. Adequacy of the results is assessed and process is repeated if found inadequate.

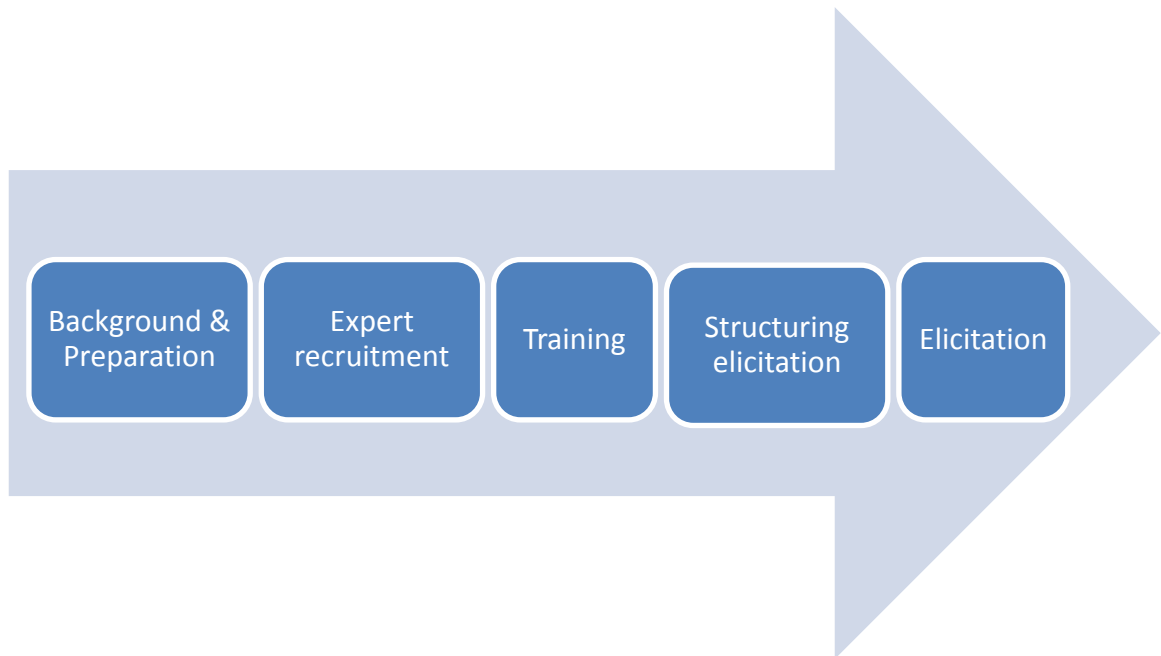

Figure 9: Expert Elicitation Process

It is important to document the evidence of expert judgment. This helps in keeping track of the rationale for responses as well as a tool for experts to enumerate all possible reasoning that can be discussed later. Elicitation can be done in number of ways. It can be done through mail by sending questionnaire or over the phone etc. Best way to conduct elicitation is face-to-face interaction. It has many advantages including exclusive availability of expert for elicitation, instant feedback and correction system, and discussions on the results. Sometimes face-to-face interactions become difficult either

due to non-availability of expert, financial constraints or other administrative difficulties. The experts are contacted either by telephone call, email or through mail. A prepared questionnaire is sent to the experts for their opinion. Their response is analyzed upon receipt and if the analyst assesses that further clarification is required, additional queries are sent back to the experts. This situation sometimes causes delays in finalization of expert elicitation. At the same time often the expert is not committed fully to elicitation process due to other commitments at their work place, if any. Face-to-face interaction helps analyst and expert to focus on the elicitation process during the elicitation period. In case of email/ mail type of elicitation, the better prepared questionnaire would help elicit expert opinions.

CHAPTER 3

APPLICATION OF DEMPSTER-SHAFER THEORY OF EVIDENCE

Discussions in previous section have highlighted some of the drawbacks of using traditional probability theory in expert opinion elicitation in context of technology valuation. Classical probability theory focuses on aleatory uncertainty, which emphasis more on what is known and tends to neglect the ignorance on part of the expert. Further research needs to be done on how to better model the uncertainty in expert elicitation used for technology valuation, while taking care of absence of absolute knowledge, and abundance of data. A hypothesis is made that treatment of expert elicitation as epistemic uncertainty can better propagate the uncertainties in technology valuation process.

A brief description of the problem setup is discussed below where epistemic uncertainty is propagated through evidence theory. Results are also compared with deterministic and probability theory based process. Results were created for a one technology portfolio including thirteen technologies [69-71].

Problem Setup

A Latin hypercube DoE was used to sample the design space of a baseline aircraft engine model. The flow path of the baseline engine can be seen in Figure 10 [72-75]. This DoE data was used to create a set of 2nd order RSE surrogate models. The inputs to this model included five TIF: Fan efficiency, HPC efficiency, combustor efficiency, HPT efficiency, and LPT efficiency. Seven system level performance metrics were regressed: specific thrust (ST), thrust specific fuel consumption (TSFC), total engine weight in lbs., total engine length in inches, total engine diameter in inches, HPC stage loading, and engine thrust to weight ratio (TWR). The engines baseline performance can be seen in Table 2. The thirteen candidate technologies can be seen in Table 3.

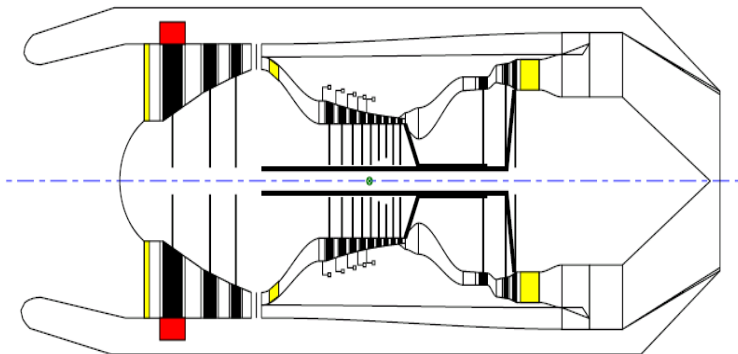

Figure 10 : Baseline Engine Flow Path and Architecture

Table 2 : Baseline Engine Performance

Performance Metric	Units	Baseline Value	Deterministic Value with Technologies
Specific Thrust	lbf/(lbm/sec)	110	113.75
Thrust Specific Fuel Consumption	1/hr.	0.88	0.88
Engine Nacelle Length	in.	98.4	94.4
Engine Nacelle Max Diameter	in.	33.6	33.1
Total Engine Weight	lbs.	2467	2727
HPC Stage Loading Coefficient	-	0.6	0.635
Thrust to Weight Ratio of Engine	-	4.46	4.17

Table 3: Candidate Technologies

Technology	Component	Symbol
Blisk Rotor	Fan	T1
	HPC	T2
	HPT	T3
	LPT	T4
Splitter Blades	HPC	T5
Circulation Control Blades	HPC	T6
Fully 3D Optimization	Fan	T7
	HPC	T8
	HPT	T9
	LPT	T10
	Com bustor	T11
Endwall Contouring	HPC	T12
Lightweight Materials	Fan	T13

Each of the five TIF was given the same set of uncertainty intervals, as seen in Table 3. The Dempster's rule for combination, was then used to propagate these uncertainties into belief and plausibility functions for the seven system responses[76].

Table 4 : Intervals of Percent Uncertainty Used in Evidence Theory

	Low	High	BPA
Interval Set 1	-1	0.5	0.7
	0.5	1	0.3
Interval Set 2	-1	-0.1	0.33
	-0.5	1	0.34
	-0.5	0.5	0.33
Interval Set 3	-1	0.5	0.6
	0.5	1	0.4

Results

Evidence theory was applied for technology evaluation process discussed in this study. Dempster rule of combination was used to combine the propositions from multiple experts. The method was run with different sample sizes to check its sensitivity against sample size.

Sensitivity Analysis

The sensitivity analysis plays an important role is determining the relative impact of inputs to the parameters of interest. Sensitivity study was carried out against all the outputs and their sensitivities to variability in the input efficiencies were quantified. The inputs which do not have any significant impact on the outputs can be filtered out from simulations for the purpose of uncertainty propagation [77, 78]. To conduct sensitivity analysis, ranges and distributions of input variables should be consistent with each other

to have an appropriate relative importance. These ranges should also cover the range of uncertainty used in evidence theory [78].

Figure 11 displays the sensitivity analysis for (thrust specific fuel consumption) TSFC. It can be observed that combustor efficiency is the major contributor to the variability of TSFC, whereas LPT efficiency has very little impact. Before leaving out any input variable from uncertainty propagation based on sensitivity analysis, it is important to do the similar analysis for each of the outputs. This can ensure that the input variable nominated for dropping out has no significant impact on the variability of the any output. In Figure 12 it can be seen that LPT efficiency is significant in case of thrust-to-weight ratio. The information obtained from sensitivity analysis provides an in-depth insight to the relative impact of uncertain variables on the outputs, which can in turn be used in the uncertainty propagation through evidence theory.

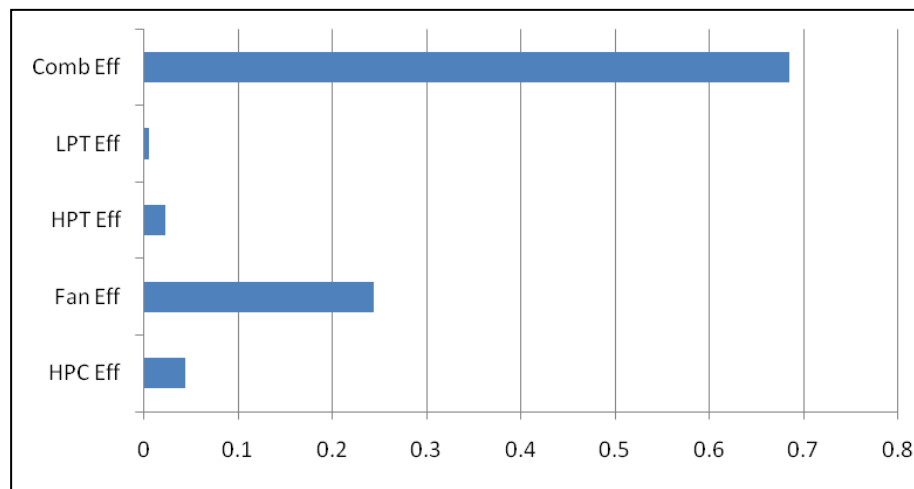

Figure 11: Sensitivity analysis for TSFC

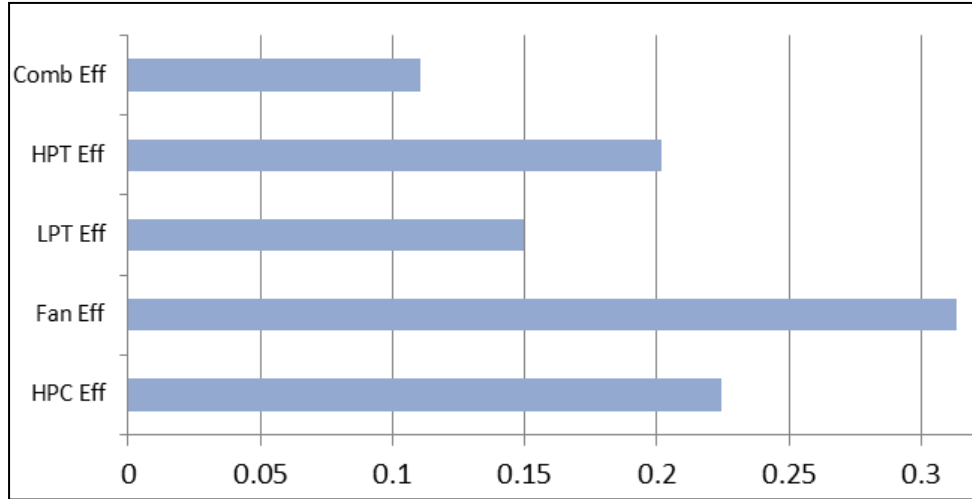

Figure 12: Sensitivity analysis for Thrust-to-Weight Ratio

Combination of Evidence

The information regarding the variability in input variables was collected from multiple experts, who have assigned different ranges and basic probability assignments (BPA) to the inputs. Input interval sets for input variables were elicited from multiple experts and the aggregation of this information was done through Dempster rule. In case of technology valuation, the elicited information revealed that the sources were independent and did not have significant conflicts. This justified the usage of Dempster rule for combination of evidence. Results of elicitation from three different experts for variation in combustor efficiency were recorded. Figure 13 represent the ranges and their corresponding BPAs.

Combination of evidence was conducted using Dempster's rule, as seen in Figure 14. This shows the resulting BPA for percent variation of combustor efficiency from baseline.

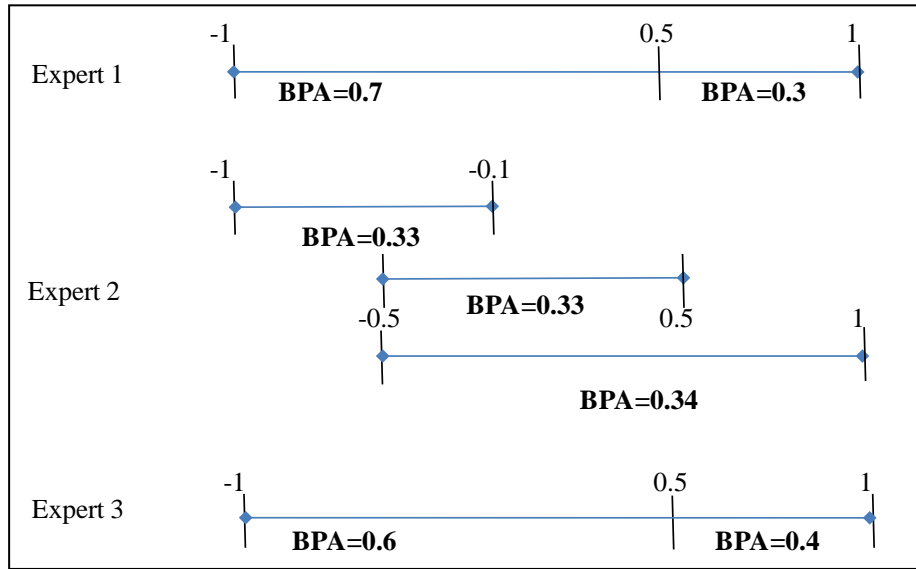

Figure 13: Intervals and associated BPAs for percent variation of combustor efficiency from baseline

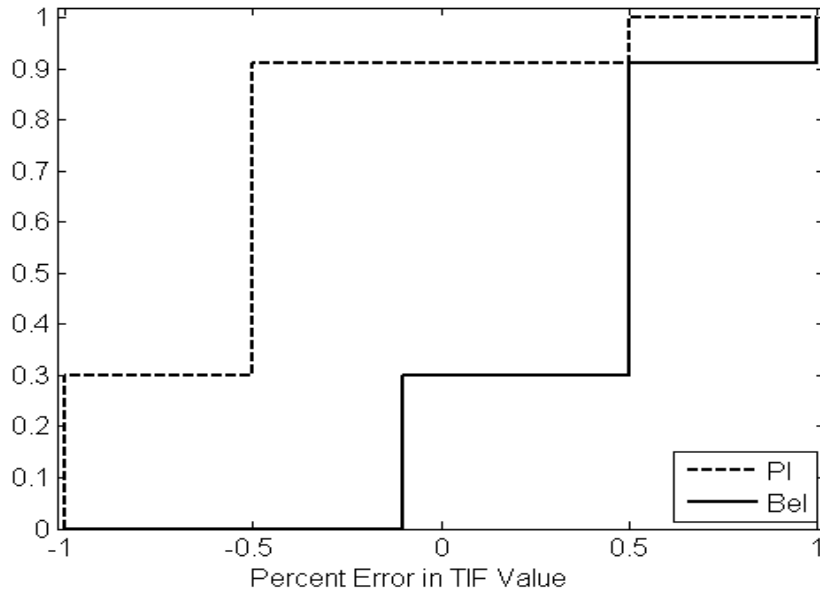

Figure 14: Plot of resulting BPA from Dempster Rule

Sample Size Sensitivity

Experiments were conducted to monitor the effect of sample size and its impact on simulations. Three sample sizes of 10^3 , 10^4 and 10^5 were evaluated. The cumulative belief (Bel) and plausibility (Pl) distribution of thrust-to-weight ratio is shown in Figure 15. The distributions from sample size of 10^4 and 10^5 were identical, so only results from sample size of 10^3 and 10^4 are displayed.

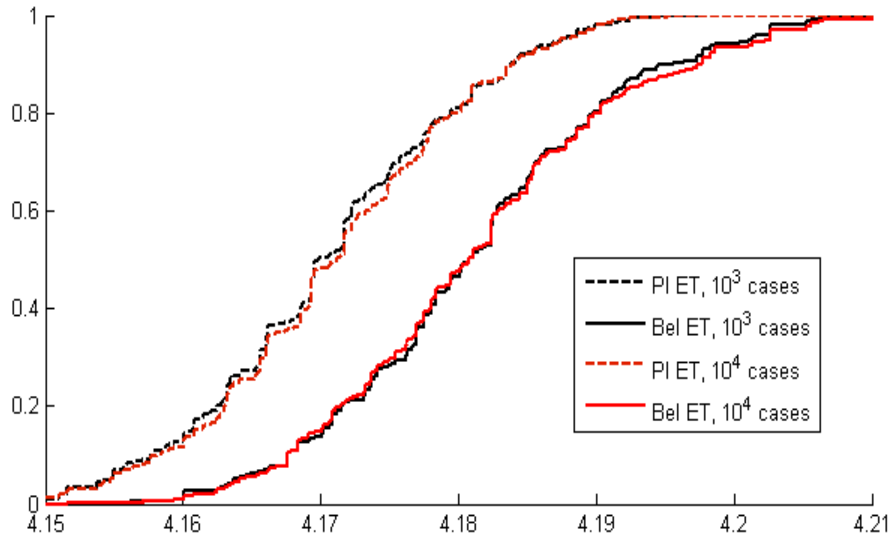

Figure 15: Cumulative belief and plausibility distributions for thrust-to-weight ratio

The sensitivity of sample size to time is shown Figure 16. Based on cumulative distributions and time factor, sample size of 10^4 was used for all simulations.

Cumulative distributions

Cumulative belief and plausibility distributions for specific thrust are shown in Figure 17. The intervals assigned to input variables can be contiguous (expert 1 and 3), overlapping (expert 2) or disjoint. The interval type, range and BPA affect the resulting

distributions of the outputs. It can be observed that the probability that value of specific thrust is less than 114 lbf/(lb/s) lies between a range of 0.15 to 1.

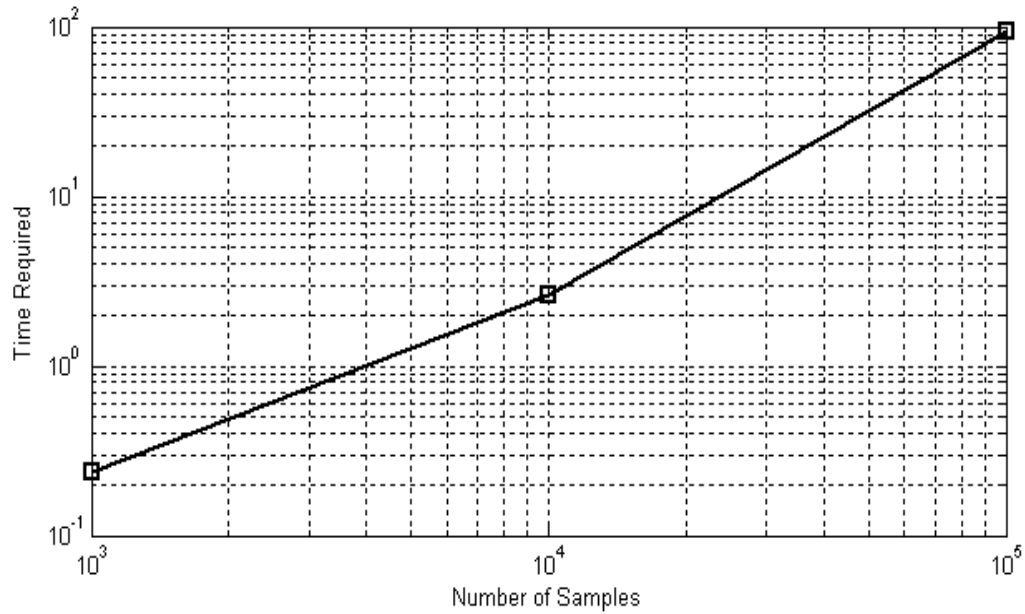

Figure 16: Effect of sample size on simulation time

Similarly it can also be deduced that there are 90 percent probability that Specific thrust value is between 113.1 to 114.8 lbf/(lb/s). In terms of the concept of cumulative density function (CDF), the belief and plausibility provide lower and upper bounds to CDF [26]. It can also be noted that deterministic value of specific thrust was calculated as 113.75 lbf/(lb/s) , when all the inputs were used as average values of their respective uncertain ranges. It can be observed that the cumulative belief that specific thrust is less than 113.75 lbf/(lb/s) is 0.01 and the cumulative plausibility that this value is less than 113.75 lbf/(lb/s) is 0.96.

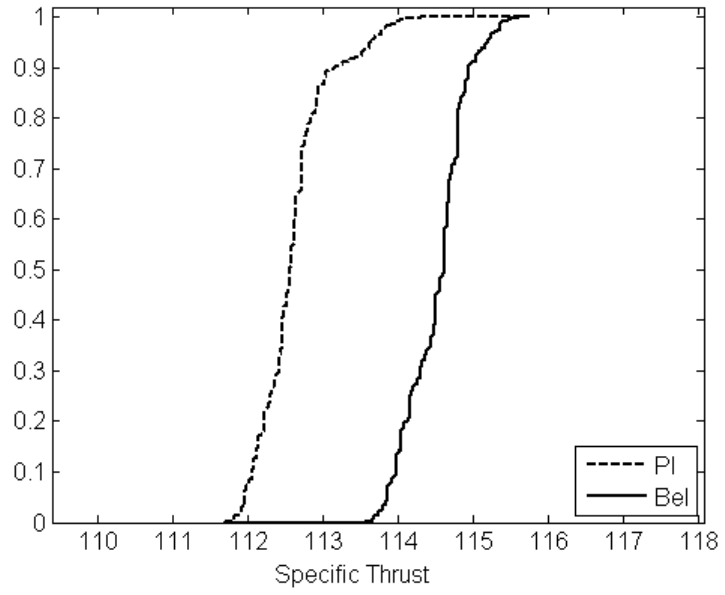

Figure 17 : Cumulative belief and plausibility distributions for Specific Thrust

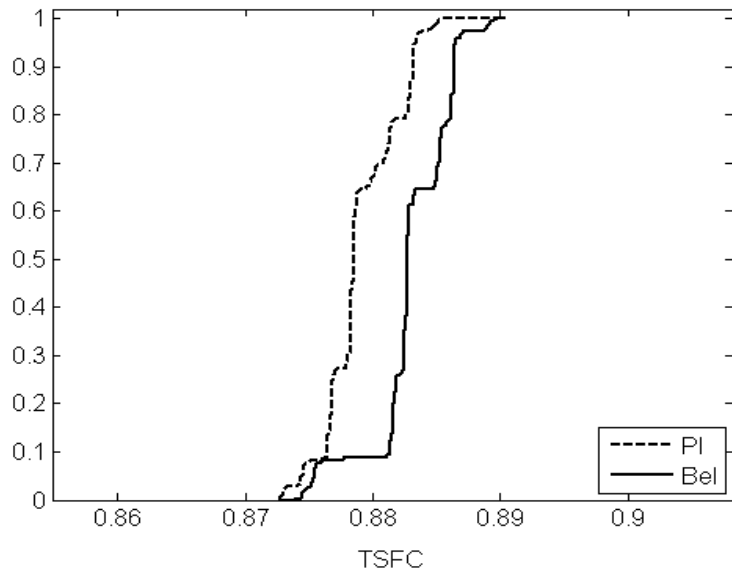

Figure 18 : Cumulative belief and plausibility distributions for TSFC

Cumulative belief and plausibility distributions TSFC and total engine weight can be seen from Figure 18 and Figure 19.

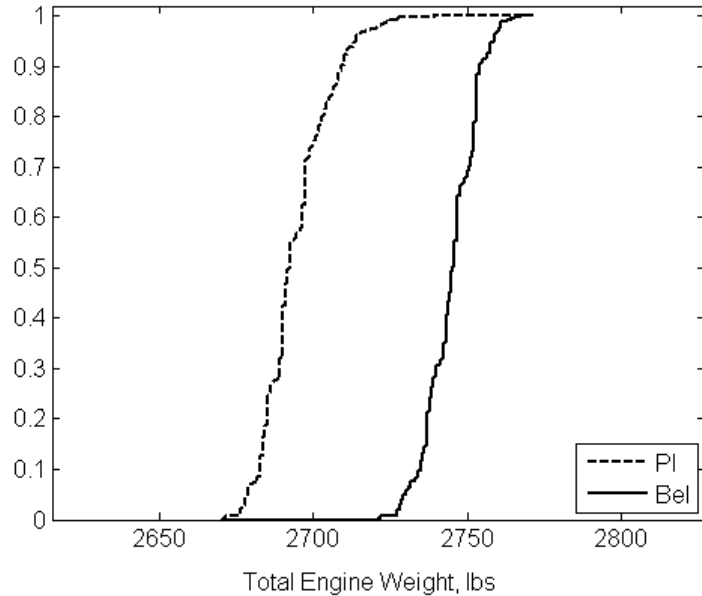

Figure 19 : Cumulative belief and plausibility distributions for Total Engine Weight

Another experiment was conducted to compare combining rules (Dempster’s rule [ET, DR], and weighted mixing [ET, WM]) within theory of evidence. Results were also generated and compared with probability theory. Cumulative belief and plausibility distributions for Thrust to Weight Ratio are shown in Figure 20. CDFs generated using probability theory can also be seen. Some comments can be made on cumulative belief and plausibility distributions. Dempster rule and weighted mixing rule produced results close to each other. In case of conflicts within expert opinions from different sources, these results are expected to be different. Similarly it can also be observed about probability that value of “thrust-to-weight ratio” is less than 4.18 is different for all three methods:

- (a) Dempster's Rule: 0.55 to 0.90
- (b) Weighted Average: 0.5 to 0.82
- (c) Monte Carlo: 0.65

It can also be observed from Figure 20 that the CDF produced by probability theory process pass outside of the plausibility and belief curves generated by either

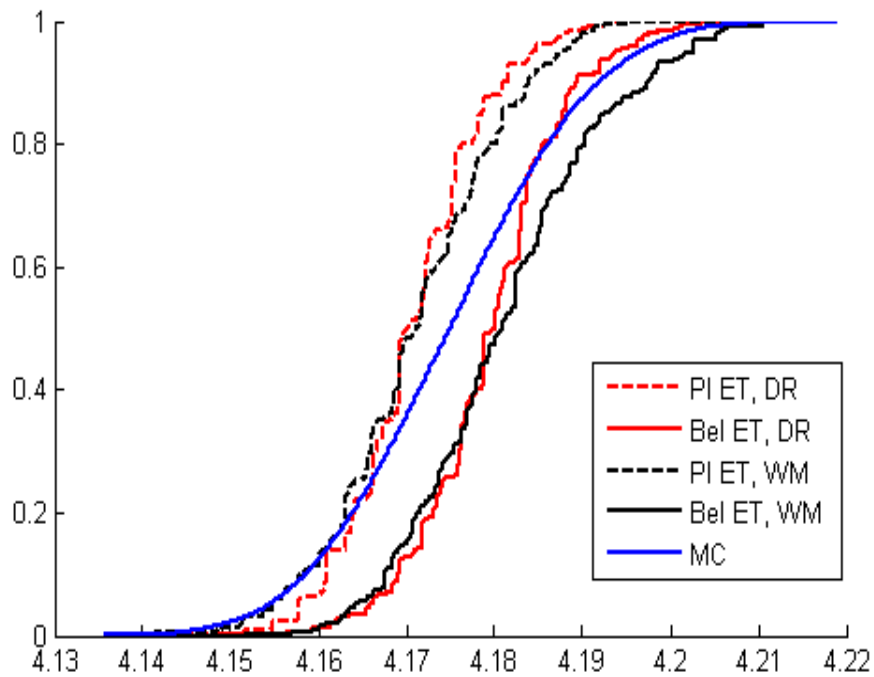

Figure 20. Cumulative belief and plausibility distributions for Thrust to Weight Ratio

Evidence Theory approach. This is a significant difference (on the order of 10%) in the calculated probability that “thrust-to-weight ratio” is less than 4.16. Although in some cases the CDF generated from probability theory fell within the bounds of Cumulative

belief and plausibility distributions, the situations where it falls outside may lead to undesirable conclusions.

CHAPTER 4

TECHNOLOGY MODELING WITH TECHNOLOGY SYNERGY

MATRICES

Technology modeling is the process of using data from expert opinion elicitation to simulate the net impact of a set of technologies on a system. Various methods of technology modeling have been proposed in previous works [79-87]. Many of these methods use a technology impact matrix (TIM) to capture the independent, one-at-a-time, impacts of all the technologies on k-factors and performance metrics. These methods assume that the effects of technologies are linearly additive. A technology compatibility matrix (TCM) may be used to filter-out technology combinations that are infeasible due to incompatibilities.

Problems with Current Methodologies

Current methods do not account for nonlinear interactions between technologies. This may lead to erroneous results for some inherently nonlinear problems. One example of this is the combined application of active aeroelastic wing technology and composite wing construction technology to commercial passenger aircraft design. When applying composite wing construction alone to an aircraft design, a structures expert may be able to accurately predict a scalar improvement in aircraft structural weight fraction due to that technology. Likewise, if an active aeroelastic wing (AAW) technology was applied in isolation to a conventional all-aluminum aircraft, an AAW expert may make a reasonable prediction of aircraft empty weight fraction reduction due to thinner wing skins and other stiffness tailoring techniques. The combination of these technologies is unlikely to be additive because of the structural complexity of integrating AAW servos with an all-composite wing structure. One interpretation of this non-linear effect is that the AAW technology has a potential to degrade the original benefit of the all-composite

wing technology. Another interpretation is that the ability to combine these two technologies represents a technology in itself—one that has a negative impact on the performance metric of aircraft structural weight fraction.

Another problem with the simple addition of technology impacts is that they may violate theoretical or physical constraints. For example, let's assume that technology A has been projected to reduce fuel consumption of an aircraft by 50%. Likewise, let's assume that technology B has also been projected to reduce fuel consumption by 50%. Simulating the combination of technology A and B by reducing fuel consumption by $50\%+50\%=100\%$ would lead to an unrealistic modeling scenario (a conventionally powered aircraft that consumed no fuel). Sometimes certain makeshift arrangements are utilized in form of a fudge factor or multipliers to reduce the additive impact of multiple technologies, but these frameworks lack the direct input from experts.

Based on these observations, further research is warranted on how expert elicitation and historical data be used to better capture the interactions between technologies in technology valuation process. A framework is needed to extract the existing knowledge from experts or available historical data about technology interactions and utilize it in technology valuation problem solving. It is hypothesized that a new set of technology synergy matrices can be introduced to capture the higher order interactions between technologies through subject matter expert opinion and historical data. This newly introduced Technology synergy matrices would record the technology interactions and better represents the physics of problem. Experiments would be setup to where results from technology valuation from linear and non-linear methods will be compared. In following section the newly proposed approach is discussed along with experiment setup and initial results.

Approach Description

Technology Synergy Matrices (TSM) are a method of capturing expert opinion regarding 2nd order and higher technology interactions. This information can be combined with TIM data to form a higher-order technology model. The TSM contains correction factors that, as seen in the scenario depicted in Figure 21, will be able to account for non-linear technology interactions. While there is only one TIM and one TCM for a given

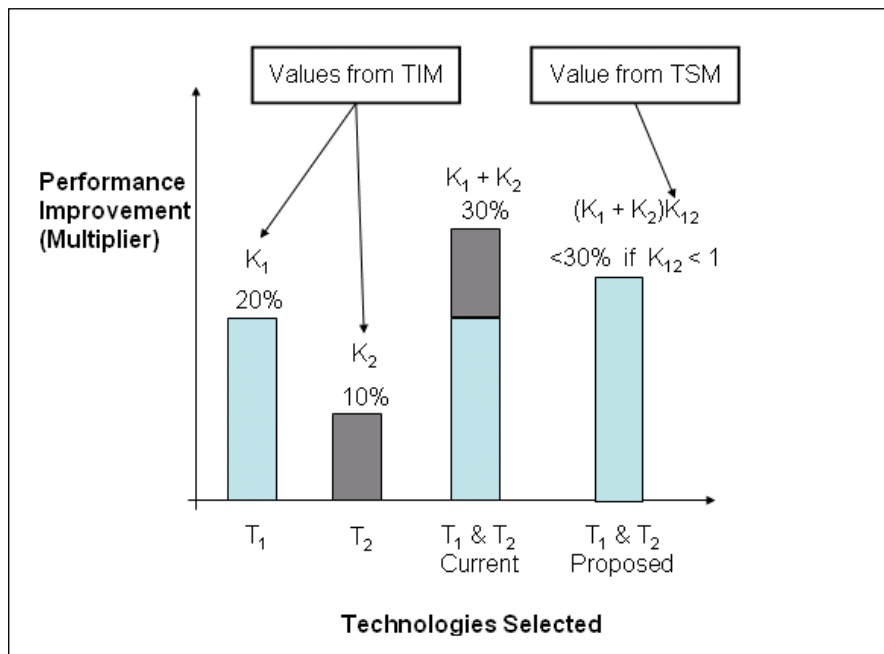

Figure 21. Notional Comparison of Current and Proposed Methodologies for the Modeling of Technology Combinations

problem, there are multiple TSM for a single technology portfolio problem. Each TSM modifies the technology impacts for a single performance metric. Each entry in a given TSM answers the question, “Given that these two technologies have both been added to the design and are interacting, by what fraction will the net additive impact of these two technologies be degraded or enhanced?” The TSM allows for 2nd order technology

impacts to enter the technology forecasting problem through expert opinion on pair wise technology interactions[88, 89].

The proposed process of technology impact forecasting with TSM includes three forms of expert opinion: technology impact matrices, technology compatibility matrices, and technology synergy matrices. For a given problem, there will only be one TIM and one TCM created. Multiple TSM will be necessary, however—one for each performance metric—to fully characterize the potential 2nd order synergies between technologies.

Technology Impact Matrices (TIM)

The TIM is a tool for mapping technologies directly to system performance

Technology Impact Matrix		Technologies						
		T ₁	T ₂	T ₃	T ₄	T ₅	T ₆	T ₇
Disciplinary Metrics	k ₁	2%	-	-	2%	6%	-	4%
	k ₂	-	1%	1%	-	-	5%	-
	k ₃	1%	-	-	-	-	3%	-
	k ₄	-	-	2%	-	1%	-	-

Figure 22. Notional Technology Impact Matrix

metrics [81, 84]. A notional example of a TIM with seven technologies (T1 through T7) and four performance metrics (M1 through M7) can be seen in Figure 22. In the TIM, each technology is listed along the vertical axis and each performance metric is listed along the horizontal axis. Every intersection of a technology and performance metric contains a scalar multiplier. This scalar represents an expert’s best guess as to how the technology modifies the performance of the system when applied by itself. For example,

in Figure 22 the intersection of technology 2 (T2) and performance metric 2 (k2) is 1%. This is equivalent to saying that technology 2 is expected to increase the value of performance metric 2 by 1% when applied to the system. Likewise, technology 2 is expected to have no effect on performance metric 1. Technology 5 (T5), on the other hand, increases the value of performance metric 1 by 6%.

Technology Compatibility Matrices (TCM)

The TCM is a tool used to account for incompatibilities between technologies.¹ During design space exploration or optimization, information in the TCM can be used to filter out technology combinations that are infeasible. A notional TCM can be seen in Figure 23 below. Both the horizontal and vertical axes of the TCM consist of the entire list of technologies. Each field in the TCM contains either the binary value 1 or 0. The value 1 indicates that the technology combination represented by that matrix intersection is feasible. The value 0 represents an infeasible combination. For example, the notional matrix seen in Figure 23 shows that technology 1 (T₁) and technology 5 (T₅) are incompatible, while technology 2 (T₂) and technology 5 (T₅) are compatible. In the

Technology Compatibility Matrix	T ₁	T ₂	T ₃	T ₄	T ₅	T ₆	T ₇
T ₁		1	1	1	0	0	0
T ₂			0	1	1	0	1
T ₃				0	1	1	1
T ₄					1	1	0
T ₅						1	0
T ₆							1
T ₇							

Figure 23. Notional Technology Compatibility Matrix

interior of the TCM, only the top diagonal of the matrix is displayed and/or used because the other diagonal portion would contain redundant information. It is important to contain this information in a single matrix (as opposed to combining this information with the many TSM) so that the combinatorial space of technology combinations can be quickly pruned. Searching through a single matrix, the TCM, is much more computationally efficient than searching through multiple TSM for this task.

Technology Synergy Matrices (TSM)

The technology synergy matrix captures the interactions between technologies that are ignored by current TIM / TCM only methodologies. When a single technology is applied to a product design, it has an expected performance improvement. This is obtained through k-factors documented in the TIM.

With the methodologies proposed in the past, when two technologies are applied simultaneously their respective k-factors are added to find a net technology impact multiplier for a given performance metric, as seen in Equation 34 and Equation 35 below [79, 82]. In Equation 34 $M_{m,baseline}$ is the baseline performance metric value for a design, while k_{net}^m is the net impact of a set of selected technologies and $M_{m,tech}$ is the simulated performance due to technology inclusion. In Equation 35 K_{im} is the TIM value found at the intersection of technology i (T_i) and performance metric m (M_m). I_i is the flag used to simulate whether a technology is applied (included in the present design) or not applied (not included). I_i is set equal to 1 if the technology T_i is being applied or 0 if technology T_i is not being applied. N is the total number of available technologies.

$$M_{m,tech.} = M_{m,baseline} \left(1 + k_{net}^m \right) \quad \text{Equation 34}$$

$$k^m_{net} = \sum_{i=1}^N (I_i)(k_{im})$$

Equation 35

TSM adds an extra layer of resolution with respect to the TIM/TCM only approach. The impact of interactions between technologies is captured in addition to individual technology impacts. A notional TSM for a single performance metric can be seen in Figure 24. Like the TCM, the TSM has every technology on both axes. Each intersection of two technologies in a TSM contains a continuous scalar value greater than 0, however. When this scalar value is equal to one, then the effect of combining those two technologies is linear. When a TSM entry is less than one, the technology combination is less effective than if the two technologies were independent (there is a mutual degradation). Likewise, if a TSM entry is greater than one, then the technology combination is more effective than if they were independent (there is a technology synergy). As with entries in the TIM, TSM entries are estimated through one or more of the following: expert questionnaires, literature reviews, or theoretical evidence/reasoning. Five methods of applying TSM scalars are proposed in this paper. Each method has been designed so that the linear technology combination method is recovered when all TSM values are equal to one.

Technology Synergy Matrix	T ₁	T ₂	T ₃	T ₄	T ₅	T ₆	T ₇
T ₁		0.9	0.8	0.85	0	0	0
T ₂			0	0.7	0.95	0	1
T ₃				0	0.7	1	1.05
T ₄					0.85	0.9	0
T ₅						0.75	0
T ₆							0.8
T ₇							

Figure 24. Notional Technology Synergy Matrix

Combination Methods

A combination method is the equation used to combine TIM and TSM into a predicted k-factor. Five combination methods are explored in this thesis: The weighted pairwise combination method, direct product method, averaged synergy method, minimum impact method, and maximum impact method.

Method 1: Weighted Pairwise Combination Method

The weighted pairwise combination method, described by Equation 36 below, attempts to directly correct the multipliers found through the simple addition of TIM values, replacing Equation 35 seen above. In Equation 36, all values are the same as defined for Equation 35. The term k_{ijm} is new, and represents the TSM correction scalar (found in the TSM matrix for performance metric m) for technology combination T_i and T_j . This method treats each TSM value as a degradation/synergy multiplier against the combined effect of two technologies.

A benefit of this method is that the selection of TSM values has a clear meaning to the user. It answers the question, “Given that these two technologies have both been added to the design and are interacting, by what fraction will the net additive impact of these two technologies be degraded or enhanced?” One downside of this method is that it cannot be applied to situations where only one technology is selected. The user must default to using Equation 35 when only one technology is activated. Another downside is that, for problems where the number of technologies is large and the number of synergies (non-one TSM values) is small, the effect of synergies is reduced. As the number of technologies becomes large, the equation becomes heavily biased by the number of technologies selected and begins to behave similarly to the linear technology model, Equation 35.

$$k^m_{net} = \frac{\sum_{i=1}^N \sum_{j=i+1}^N (I_i)(I_j)[k_{im} + k_{jm}]k_{ijm}}{\left[\sum_{i=1}^N I_i \right] - 1} \quad \text{Equation 36}$$

Method 2: Direct Product Method

The direct product method applies all TSM scalars directly to each technology impact. This method is the most accurate when each technology is only involved in one synergy (there are no 3rd order interactions). Unlike the Weighted Pairwise Combination, this method is not biased by the number of technologies present. If a technology is involved in multiple 2nd order synergies, then those synergies combine through multiplication, as seen in Equation 37. This may lead to unanticipated and highly erroneous results for cases where 2nd order synergies interact, however.

$$k^m_{net} = \sum_{i=1}^N \left((I_i) k_{im} \prod_{\substack{j=1 \\ j \neq i}}^N k_{ijm} (I_j) \right) \quad \text{Equation 37}$$

Method 3: Averaged Synergy Method

This method is a modification of the Direct Product Method that attempts to address the problem of 3rd and higher order technology synergies. Instead of allowing multiple 2nd order interactions to combine through multiplication, all 2nd order interactions are averaged before being applied to a given technology impact. This can be seen in Equation 38. This would prevent the unrealistically high or low synergies seen when one applies the Direct Product Method to problems with multiple technology interactions.

$$k^m_{net} = \sum_{i=1}^N \left((I_i) k_{im} \frac{\sum_{\substack{j=1 \\ j \neq i}}^N k_{ijm}^{(I_j)}}{N-1} \right) \quad \text{Equation 38}$$

Method 4: Minimum Impact Method

This method is another modification of the Direct Product Method that addresses the issue of higher order technology synergies for a special case. It is most appropriate when impact of simultaneous application of multiple technologies is restricted by minimum improvement by any technology. In this method, the smallest applicable non-unity technology synergy is applied to each technology impact. This provides the most conservative estimate of a technology's effect. Equation 39 shows the formula behind this method. It should be noted that, when applying Equation 39, technology synergies that are equal to one should not be included in the averaged. Therefore, in Equation 39, N represents the number of technology synergies that are not equal to 1, while k_{ijm} represents the technology synergies that are not equal to 1.

$$k_{net}^m = \sum_{i=1}^N I_i k_{im} [\min(k_{ijm})_{\forall j: k_{ijm}^{(j)} \neq 1}] \quad \text{Equation 39}$$

Method 5: Maximum Impact Method

This method is the final modification of the Direct Product Method for higher order technology synergies. In this method, the largest applicable technology synergy is applied to each technology impact. This provides the least conservative estimate of a technology's effect. Equation 40 describes the formula behind this method.

$$k_{net}^m = \sum_{i=1}^N I_i k_{im} [\max(k_{ijm})_{\forall j: k_{ijm}^{(j)} \neq 1}] \quad \text{Equation 40}$$

TSM Method Selection and Data Collection Process

The methods presented earlier can be applied independently to each metric in TIM. Different metrics can have different methods to determine the net effect of combined technologies. To accurately select the best suited method for higher order impacts, various approaches can be adopted. Suggested approaches include expert opinion elicitation [1, 90] and calibration based on available experimental/physics based results.

Expert Opinion

While elicitation of expert opinion for construction of technology impact forecasting, the information on nature of behavior of each metric can be assessed. This can help in deciding about selection of method for TSM implementation of higher order interactions. For example in case of noise improvement technologies, the minimum improvement in maximum noise generating component of a system may be suggested by experts. This is based on expert's experience because the minimum reduction in the

component generating maximum noise can be a deciding factor for complying FAA noise regulations. According to this input, minimum impact method can be adopted for noise related k factors in TIM.

Calibration

In some cases it is possible to have a set of historical or experimental data for a particular problem. Calibration against historical data can give insight on the type of method to be adopted for a particular method. It can show the impact of combining certain metrics on the output of the environment. Sensitivity analysis of metrics can also provide additional information during calibration process.

User Defined K-factor Limit

In many situations, there are known upper or lower limits to the net impact on a k-factor. These limits may be based on either fundamental physics or practical constraints to the problem. A simple way of capturing these limitations is by applying a vector of user defined upper and lower limits to the calculation. If the k-factor calculated through the use one of the five methods described above violates one of these limits, then the prediction should be replaced by the limit value. This can be accomplished through the use of “IF” statements in a computer code. This adds an additional nonlinearity to the technology selection problem and should prevent unrealistically large or small net technology impact predictions from occurring.

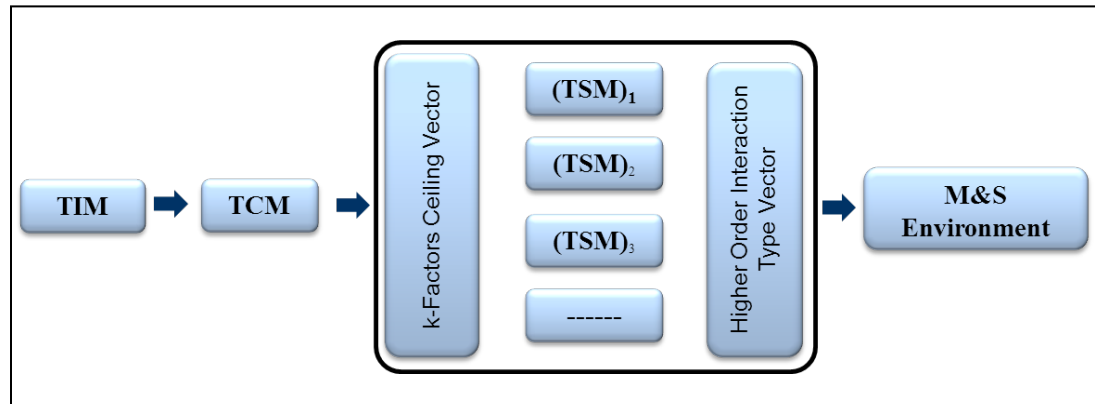

Figure 25. Integration of TSM in Technology Evaluation

Technology Evaluation and Selection

After calculating net k-factors for a given set of technologies from the combination of TIM, TCM, and TSM, using either Equation 36, Equation 37, Equation 38, Equation 39 or Equation 40 above and applying k-factor limits, technologies may be simulated by either inputting these net k-factor values directly into a modeling and simulation (M&S) environment or by applying them to the M&S environment responses using Equation 34 as shown in Figure 25. This will produce technology impacted design performance estimates. Once the capability to simulate a package of technologies exists, a method for testing multiple technology packages and selecting the “optimal” is then required. One of the following techniques may be used to solve this technology portfolio optimization problem: Multi-Attribute Decision-Making (MADM) techniques such as TOPSIS (Technique for order preference by similarity to ideal solution), technology frontiers, technology sensitivities, or stochastic optimization techniques such as Genetic Algorithm [82, 91, 92]. Using an appropriate technique from the list above, an optimized combination of technologies may be selected.

Experiment Setup

A notional aircraft design problem is used to compare the behavior of the various technology modeling methods. In this example, seven notional technologies are investigated. These technologies are mapped to effects on four aircraft cruising performance metrics: cruising speed (V_{cruise}), lift to drag ratio (L/D), specific fuel consumption (TSFC), and aircraft gross weight at start of cruise (W_0). Using the Breguet range equation (Equation 41) these four performance metrics can be used to simulate the total fuel burn for a cruise mission segment at fixed speed and altitude (W_{fuel}). The objective for this example problem is to select the technology combination that minimizes this total fuel burn, according to the transformation of the Breguet range equation seen in Equation 41.

$$R = \frac{V_{\text{cruise}}}{TSFC} \left(\frac{L}{D} \right)_{\text{cruise}} \ln \left(\frac{W_0}{W_1} \right) \quad \text{Equation 41}$$

Table 5: Baseline Aircraft Assumptions

Cruise Range	3500 Miles
TSFC at Cruise Conditions	0.8 1/hr
L/D at Cruise Conditions	16
Gross Weight at Start of Cruise	130,000 lbs.
Cruise Speed	760 ft/sec

$$W_{fuel} = (W_0) \left(1 - \exp \left(\frac{-R(TSFC)}{V_{cruise} \left(\frac{L}{D} \right)_{cruise}} \right) \right) \quad \text{Equation 42}$$

The baseline performance metrics used in this problem can be seen in Table 1. These values approximate the performance of a medium range civil transport aircraft. In this problem, notional technologies 1 through 3 represent engine technologies while technologies 4 through 6 represent aerodynamic technologies. Technology 7 represents a notional technology that couples engine and aerodynamic performance (such as circulation control technology).

Results

A direct comparison between different methods is shown in Figure 26. This comparison is based on an identical portfolio for all the methods. Reduction in fuel burn

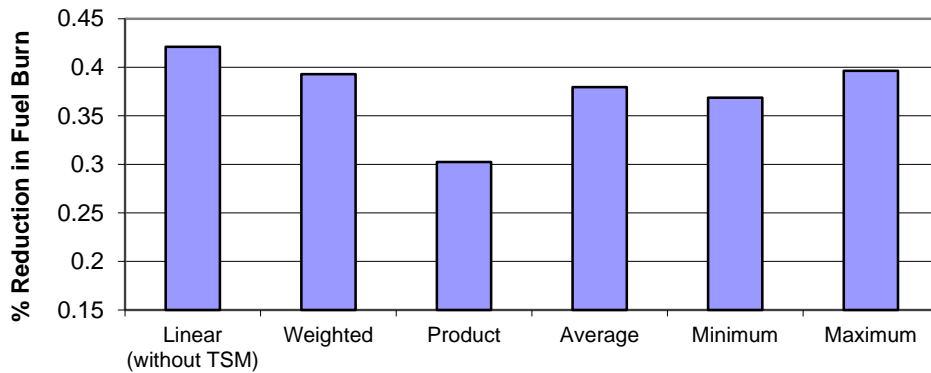

Figure 26. Comparison between TSM methods application

is compared while applying TSM for a same set of technologies. It can be observed that traditional approach without TSM gives maximum reduction in fuel burn. Direct product method yielded minimum improvement whereas weighted pair wise combination and maximum impact methods resulted in higher values. The values of different methods can also be constrained by upper ceiling defined by user in accordance with limits of the physics of the problem.

Each of the TSM combination methods were run on the example problem described above. Each method produced a unique Pareto front of technology portfolios. These can be seen in Figure 27 and Figure 28. Figure 27 shows that linear approach gives better results almost all the times. This trend was expected as in case of linear approach all the improvement factors from individual technologies are added and maximize the benefits of the technologies. The results obtained from this traditional approach often violate the physics based constraints of the problem. Introduction of TSM can be observed as compared to traditional additive approach. It should also be noted that

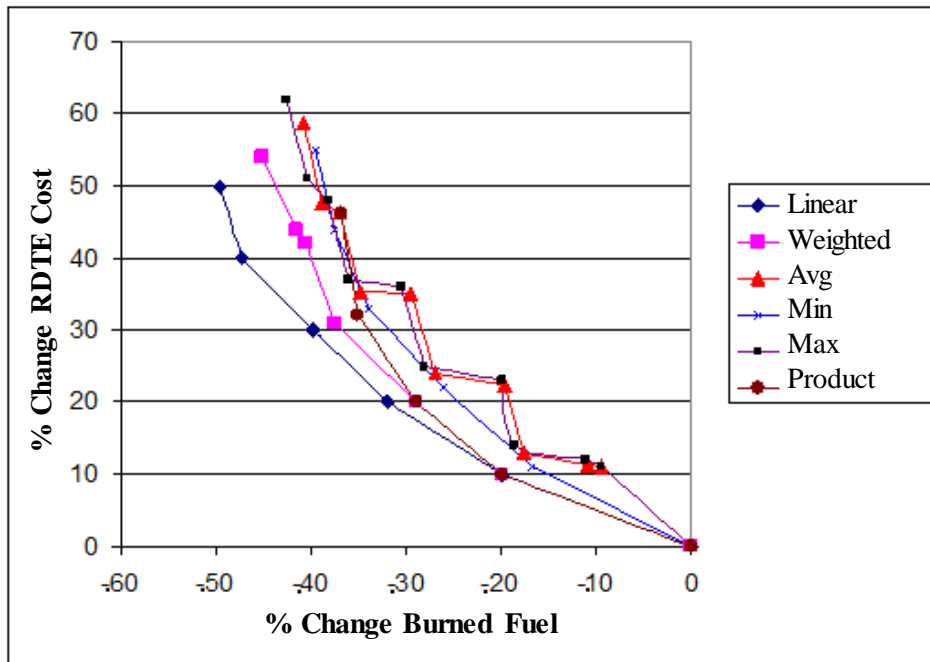

Figure 27. Pareto Front for Final Case

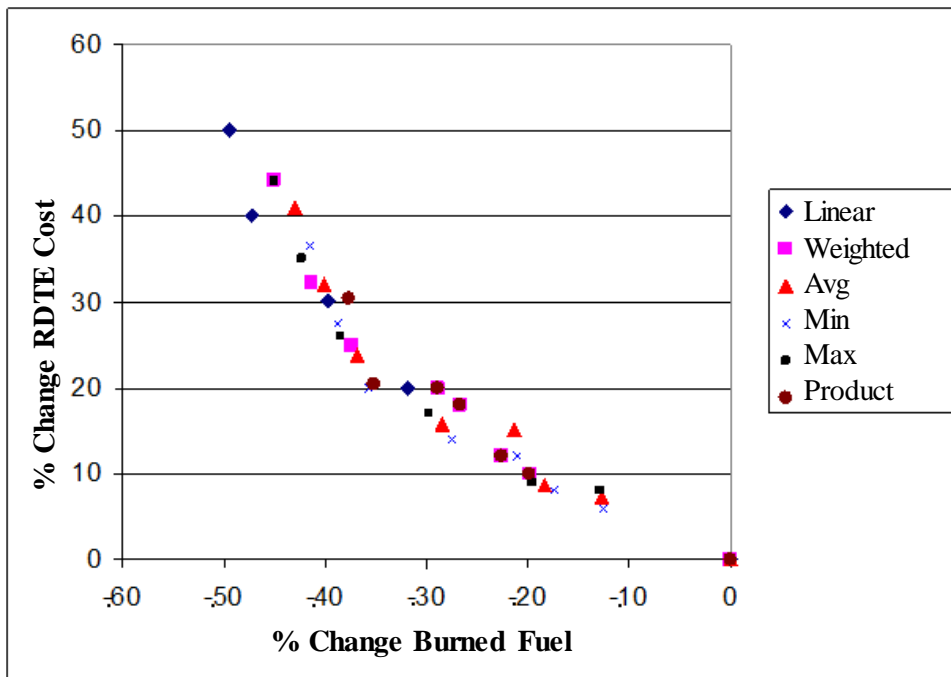

Figure 28. Pareto Front for Extreme Case

the Pareto fronts of each method may represent different portfolios. Different methods for application of TSM generate different Pareto fronts. This indicates that technology evaluation process can be calibrated and improved with introduction of TSMs with suitable selection.

TOPSIS was used as a decision method to select a single technology portfolio among the Pareto efficient technology portfolios. The same TOPSIS weightings were used to select the best portfolio in each case. The selected portfolio can be seen in Table 6. These results show that the selection of a TSM method and inclusion of higher order technology modeling information can have a significant impact on the predicted performance of a system. A 10% difference in predicted fuel burn and RDTE cost was seen, depending on the TSM methodology selected. The result from Table 6 shows that, even for a relatively simple problem, the selection of a TSM method may also lead to a

different technology portfolio selection. While most TSM methods indicated that T1 through T5 should be selected, the use of the Direct Product Method would lead a user to not select T1. Thus, the selection of a TSM methodology is non-trivial, and deserves further research. The exploration of the applicability of these TSM methodologies is one major goal of this study.

Table 6. Selected portfolios based on best cruise performance

Best Cruise Performance		
Technologies Selected	% Reduction in Fuel Burn Estimated	% Increase in RDTE Cost Estimated
T1+T2+T3+T4+T5	0.49	50.0
T1+T2+T3+T4+T5	0.45	54.0
T2+T3+T4+T5	0.36	46.2
T1+T2+T3+T4+T5	0.38	47.7
T1+T2+T3+T4+T5	0.39	55.0
T1+T2+T3+T4+T5	0.42	62.0

CHAPTER 5

FINANCIAL MODELING

Traditionally, gas turbine economics has been evaluated through NPV models based on a discounted cash flow (DCF) approach. This approach gives limited insight regarding the future value of a gas turbine design. DCF valuation assumes that investments are fixed and there is no uncertainty on inputs to the process. The projects are tackled as now or never basis [93-95]. Managerial flexibility is ignored and passive decision making is performed without consideration of economic uncertainties. In order to account for these uncertainties and incorporate dynamic decision making, and managerial flexibility, real options is used to produce an economic analysis of each technology portfolio. This technique can capture market related uncertainties which are otherwise neglected in the technology development process. This provides more robust and highly competitive alternate to traditional DCF approaches [94-96]. Real Options Analysis provides the link between net system performance, component design parameters, and system economic metrics. Real options analysis follows multiple step approach.

Real Options Process

Real Options process can be divided in six steps as shown in Figure 29 in the context of technology development. This process can be modified depending on application and specific requirements of the system.

Value Model

First a value model needs to be created that transforms performance improvements due to incorporation of new technologies into financial benefits. It is

function of technical as well as market related parameters. The output of value function acts as input to real options analysis.

Sensitivity Analysis

Sensitivity analysis of all the inputs to values function enables the designer to ignore the inputs with negligible impact on outputs. This step helps the designer to reduce the dimensionality of the problem. The important factors are then used in calculations of volatility.

Volatility calculations

Historical trend of important factors is gathered and used for volatility calculations. In case of more than one variable, their effect is lumped in the value model and then the volatility of value model is calculated. In certain cases Monte Carlo simulations may be employed to estimate the value of the technology or a portfolio[94].

Problem Definition

This step is important because according to problem at hand the appropriate method is selected for real options valuation. In case of technology development there many phases involved in the process with costs associated with each of them. At the same time theses phases are dependent on each other and success in one phase is a pre-cursor of next phase. For this kind of problems with various phases sequential compound option is a good choice. Sequential compound option takes place when the project has multiple phases and success of one phase is dependent on previous phases.

Modeling and analysis

In this phase, volatility and baseline from value function are used to calculate the expanded net present value (eNPV) of the technology or a portfolio in case of multiple technologies. eNPV is the sum of deterministic baseline NPV and the options value of

the technology. eNPV is then used as objective function in technology or portfolio prioritization by replacing DCF based NPV.

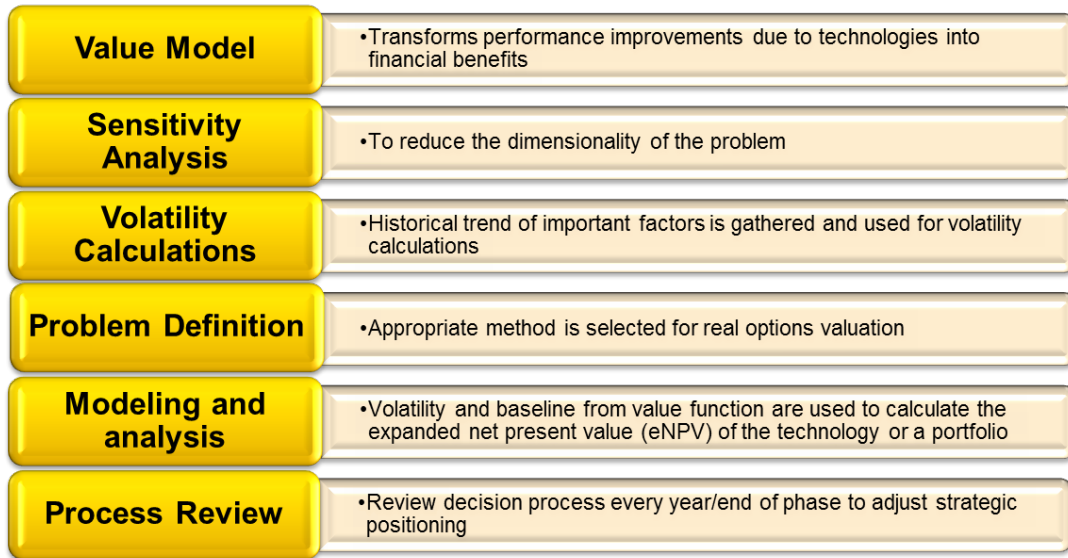

Figure 29. Options Valuation Process

Decision Making and Process Review

Based on the results from real option analysis, the real options value can be used in number of ways depending on the goals of the study. It can be used in technology selection out of the large pool of alternatives. Technologies with higher options value in presence of market uncertainties are ranked higher than the ones with lower options value. In case of multiple objectives, this criterion may be adjusted accordingly. Real options analysis can also be used to assess the valuation of competing technologies. These technologies are the ones, where a technology needs to be abandoned to select another technology. The competing technologies have some value associated with them and various possible paths can be generated based on future uncertainties. Value of each

of competing technology over period of time along arbitrary selected path can be observed. A scenario based paths can be valuated to choose the right technology.

CHAPTER 6

METHODOLOGY

This research is focused on uncertainty propagation in technology prioritization process. The proposed methodology use Dempster-Shafer theory of evidence to capture uncertainties in the input variables of the existing processes. It also addresses the non-linear behavior in the technology interactions within technology portfolios.

Technology Forecasting Methodology

A schematic of this methodology is shown in Figure 30. Details of individual steps have already been discussed in previous sections. A brief introduction of each step in discussed here.

Creation of M&S Environment

The methodology starts with creation of a modeling and simulation environment, which can accept the technology impacts as inputs and gives responses of interest as outputs. In case of gas turbine problem this environment consists of a multi-disciplinary design environment encompassing compressor, combustor, turbine and combine cycle codes. Relevant subsystem or disciplinary models may be linked to provide a total system simulation capability. The complete set of inputs and outputs of this system simulation can be explored using a coarse design of experiments (DoE). This will provide a first-cut indication of input-output sensitivities. Inputs that are of negligible impact with respect to the range of the design space under exploration can be defaulted to an average value to reduce the dimensionality of the problem. An additional DoE, exploring only the

significant variables, provides data to create a set of surrogate models. In case M&S environment is computationally expensive, surrogates may be generated for faster simulations. Surrogate models are fast-executing analytical models that emulate the original simulation. The models should be formulated so that the inputs are technology impact factors (TIF) and the outputs are system performance metrics. They form the backbone of the proposed method [88].

Expert elicitation and Technology Modeling

The second step in using the complete methodology is the elicitation of expert opinion. This involves surveying experts individually as well as in groups to determine how a given technology will impact the TIF inputs to the system. The ranges and respective BPAs should be collected for implementation of evidence theory [1, 17, 63]. Technology impact matrices, technology compatibility matrices and technology synergy matrices are generated in this step.

Next, a TSM aggregation method is selected and combined with the surrogate models and TIM/TSM data. The input of the technology model is a vector of selected technologies and a vector of TIF errors. The output of this model is a single vector of system output values [88].

Financial Modeling

Fourth step consists of financial modeling to assess the monetary aspects of technology valuation process. In this step a value model is constructed to link performance improvements with financial benefit. Market related uncertainties are identified and sensitivity analyses are conducted to reduce the dimensionality of the

problem. Volatility of the value model is calculated and real options analysis is applied to ascertain the extended net present value of the portfolio.

Uncertainty propagation

Evidence Theory is used to aggregate the expert elicited uncertainty intervals and subsequently propagation of epistemic uncertainty. Various aggregation techniques are available as discussed in earlier sections. Appropriate technique can be applied for aggregation of evidence. The uncertainty propagation routine of Evidence Theory wraps the technology model. This will create a larger model that, for a single input vector of selected technologies, produces a plausibility and belief function for each system output.

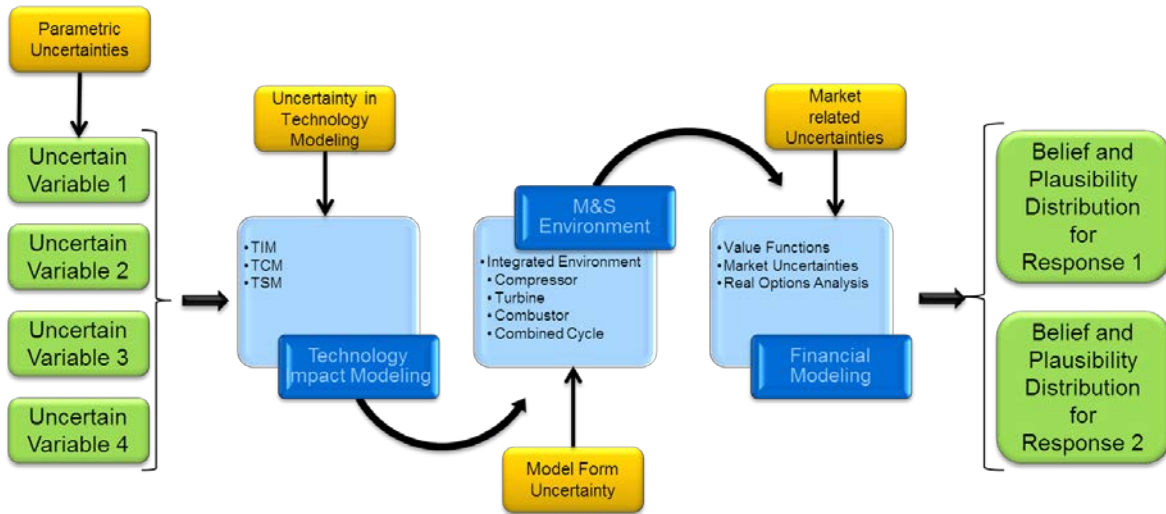

Figure 30. Uncertainty Propagation in Technology Valuation

Quantification of Epistemic Uncertainties in Multidisciplinary Environments

The uncertainties in technology valuation process for Power Generation Systems were evaluated in this study. Due to long lead times and huge investments in potential technologies make it an interesting problem from uncertainty study perspective. It has

been discussed in previous chapters that mostly epistemic uncertainty characterizes the systems involving expert elicitation. In multidisciplinary environment these uncertainties become more complex as they originate from multiple sources. Adequate identification of these sources of uncertainty and their propagation is vital to perform the meaningful analyses.

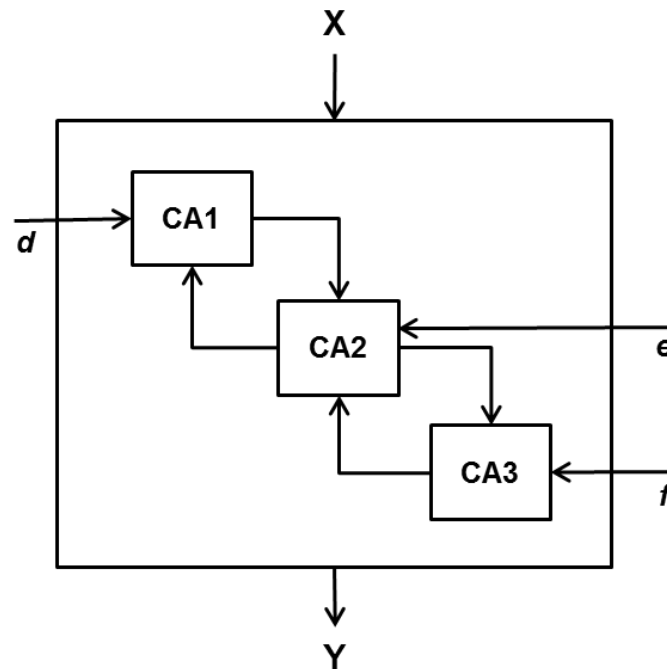

Figure 31. Multidisciplinary Environment

Figure 30 represents a multidisciplinary environment. CA1, CA2 and CA3 are three subsystems who are interacting with each other. Uncertain variables d , e and f are input to CA1, CA2 and CA3 respectively. d , e and f has associated basic probability assignments too as shown in Figure 32.

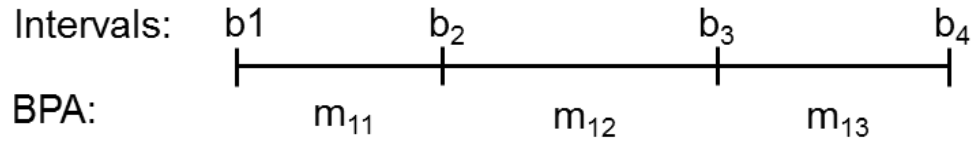

Figure 32. Interval specification for Dempster-Shafer theory of evidence

Modeling and Simulation: Multidisciplinary Environment for Power Generation System

A multidisciplinary environment for combined cycle power generation system was selected as the example to demonstrate the uncertainty quantification and propagation process. Figure 31 represents the overall structure of the environment. These models were created from or validated against proprietary data in combination with available literature of existing power generation systems. Details of individual codes are discussed in following paragraphs.

Compressor

The compressor model is based on the technology based polytropic efficiency curves as a function of pressure ratio and mass flow. The compressor polytropic efficiency then used to calculate the power requirements. These curves were converted to a response surface for ease of use in integrated environment.

Combustor

Combustor model is obtained from a relation between Nitrogen Oxide (NO_x) emissions and primary zone temperature. This relation is dependent on fuel-air mix ratio (F_u). Lower ratio would have positive impact on the efficiency. In these simulations the

NO_x level is kept constant while trying to achieve higher primary zone temperatures and thus getting better efficiencies.

Turbine

For turbine a one-dimensional meanline flowsolver was used. It used equations of mass, momentum and energy. The inputs of this model are inlet and outlet temperatures as well as different geometric variables. The outputs consist of stage efficiencies, cooling and leakage flows. The code has a built-in optimizer too, which calculates the optimized turbine efficiency as an additional option. An external optimizer can also be employed to achieve the same objective.

Thermodynamic cycle calculations for gas turbine were done with another FORTRAN based code. It maps the inlet cooling mass flows, compressor pressure ratios and stage efficiencies with turbine efficiencies, power and exhaust-mass flows.

Combined Cycle

Combined cycle was modeled with the mapping between Fuel flow, enthalpy, exhaust mass flow, exhaust temperature and combined cycle characteristics such as efficiency and power. A representative design structure matrix for combined cycle power plant is shown in Figure 33.

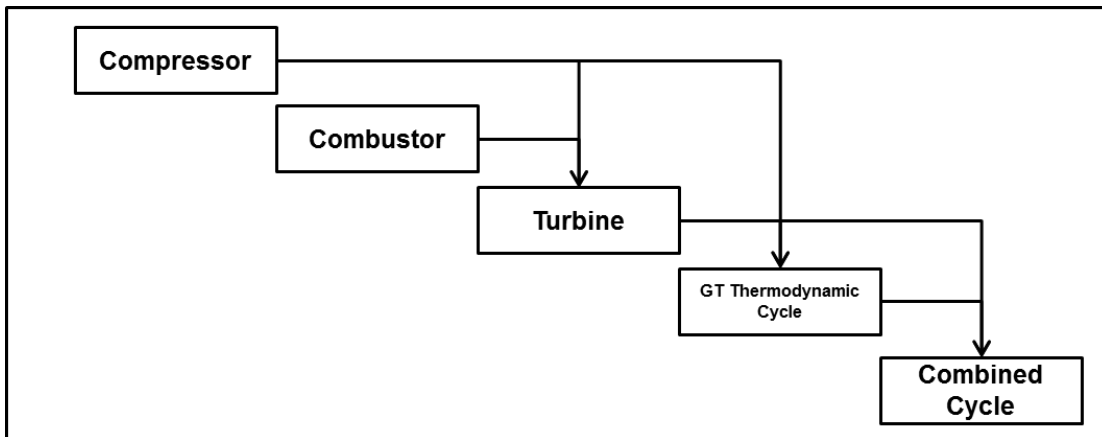

Figure 33. Multidisciplinary Environment for Combined Cycle Power Plant

Surrogate Model

A surrogate model is a fast executing regression of a training data set. It is in the form of an algebraic equation which is designed to be a substitute for the physical model of a system. In most cases it is regressed from data produced by the high fidelity model such as computational fluid dynamics (CFD) solvers, finite element method (FEM), etc. These surrogate models are only valid over a predefined subset of the ranges of the original model.[97]

A well-constructed surrogate model will have a capability to estimate the value of the response to within the error tolerance of the original high fidelity analysis code. In order to make a surrogate, first step is selecting a proper high fidelity code. An appropriate Design of Experiments technique is used to determine the points at which the code should be run in order to return the most information for the fewest number of runs. The results from the code are then compiled with their associated input parameter values, and regression is used to create a response surface that closely matches all of the inputs & outputs. One surrogate model must be created for every response of interest. Goodness of

Fit analysis is used to check how well the approximation reproduces the original code, both for the points used to create the surrogate model and for new points that were not used in the surrogate generation. If the discrepancies between the approximation and the original code are small, and no patterns are observed in the distribution of the errors, the surrogate is considered as acceptable. A surrogate model cannot be used to evaluate parameter inputs outside the ranges used in its generation.[82, 98]

The surrogate model is useful for design and optimization problems for a number of reasons:

- (a) A surrogate model can run on any platform (e.g. Windows, Mac, Linux or UNIX).
- (b) A surrogate model can be evaluated very quickly, in contrast to the original physics-based analysis code.
- (c) The sensitivity of the response to changes in the input variables can be determined easily and quickly through partial derivatives.
- (d) The optimum value of the response can be found quickly and easily.

In addition, surrogate model makes it easy to collaborate between different entities. Companies may spend a great deal of money and effort developing sophisticated analysis codes, which they then guard closely to protect their investment. Since it is impossible to use a surrogate model to determine anything about the underlying code, a company can distribute a surrogate model of its code to partners without compromising the code's security.

There are many techniques, which can be employed to generate surrogate models. Common surrogate models include response surface equations (RSE), Gaussian process models (GP), radial basis functions (RBF), and neural networks [97, 99-101].

Neural Network Overview

Due to highly nonlinear relationships between variables, a neural network surrogate model was used. The neural network is a non-linear surrogate model inspired by the architecture of the human brain [102-107]. A neural network is created by

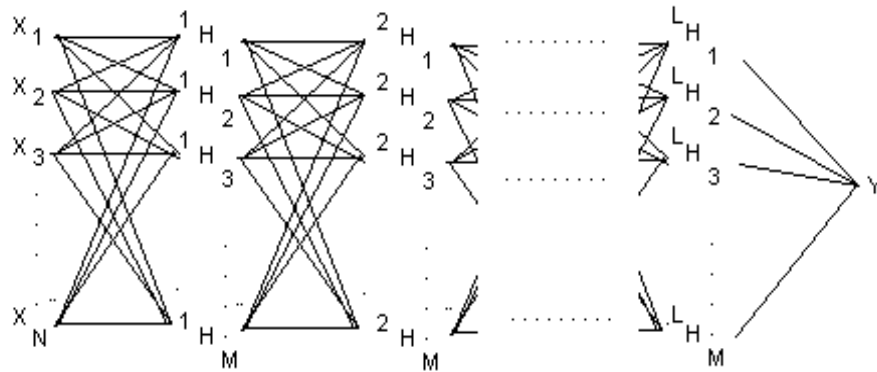

Figure 34. The Generic Neural Network

combining multiple linear regressions and non-linear activation functions. It can approximate any function arbitrarily well as long as there are enough neurons in the hidden layer [103, 104]. A generic neural network representation is shown in Figure 33. This neural network is a surrogate model for the response Y as a function of the inputs X_1 through X_n . There are L neural network layers with M nodes per layer.

Each node's output is constructed from a linear regression passed through a nonlinear activation function, as seen in equations 1 through 3 below.

$$F_x(x) = P(X \leq x) = \int_{-\infty}^x f_x(x) dx \quad \text{Equation 43}$$

$${}^k H_i = f_{\text{activate}} \left({}^k w_{i0} + \sum_{j=1}^M {}^k w_{ij} {}^{k-1} H_j \right) \quad \text{Equation 44}$$

$$Y = f_{\text{activate}} \left({}^{L+1} w_{i0} + \sum_{j=1}^M {}^{L+1} w_{ij} {}^L H_j \right) \quad \text{Equation 45}$$

Given enough nodes, the neural network can replicate any function to an arbitrary degree of accuracy. As the number of layers and/or nodes approaches infinity, the approximation error of a neural network approaches zero. Thus, the neural network acts as a “universal approximation” for functions of arbitrary complexity.

The Basic Neural Network Fitting Procedure

In order to fit a neural network to a set of training cases, the user must first select an appropriate activation function, the total number of hidden layers to be used, and the number of nodes to use in each layer. The neural network is fit by finding the set of weights for each link in the neural network that minimizes the least squares error over the entire training data set. This weights optimization problem is, in general, multi-modal and will require a stochastic optimization heuristic for its solution (such as the Genetic Algorithm). The complexity and size of the weights optimization problem scales with the number of layers and nodes selected, as well.

The basic neural network fitting procedure is not as straightforward as the fitting procedure for response surface equations. While superior to the RSE in ability to model highly non-linear responses, the neural network is prone to over-fitting. In other words,

the neural network can provide a surrogate model that exhibits extremely low error near training cases and very high elsewhere in the design space (also known as poor model generalization). Also, because stochastic fitting procedures are generally used to train the network, the same fitting problem will produce a different answer each time it is solved. The weights values may vary wildly amongst solutions. Cross-validation and multiple training tours are used to combat these problems and provide more consistent neural networks of higher quality [107].

In order to check the validity of surrogate model, the following metric are evaluated:

- (a) R^2 value
- (b) Actual by predicted plot
- (c) Residual by predicted plot
- (d) Model fit error distribution (MFE)
- (e) Model representation error (MRE)

The R^2 value is a mathematical measure that estimates how well the assumed functional form of the response measures the variability of the supplied response data. A perfect fit of the response data corresponds to a R^2 value of 1.0 and a 'no fit' corresponds to a R^2 value of 0. As a general rule of thumb, a R^2 value greater than 90% represents a good model fit. [108, 109]

The residual is the error, which is the difference between actual value and predicted value. A good Residual by Predicted plot will result in a random scattering of the data points about zero with no distinguishable pattern and a small magnitude relative to the predicted value. Random scattering is indicative of the error in the assumed model being randomly distributed as a standard normal distribution, i.e., $N(0,1)$. If the ratio of

the total span of error to the minimum of the predicted is less than 5%, the surrogate model may be valid.[108, 109]

In addition of R^2 and Residual plot, Model Fit Error (MFE), Model Representation Error (MRE), and actual by predict plot are also use to check the fitness of the neural network models for all responses. The Model Fit Error (MFE) distribution shows the magnitude and shape of the error from the Residual plot in terms of a histogram. The error associated with neglecting effects in the model is valid if the error is similar to a standard normal distribution, $N(0,1)$, which corresponds to approximately +/- 2 to 3% error. Model Representation Error (MRE) should be similar to the MFE distribution with only a slight widening. The actual behavior of the response may be some higher order or logarithmic function such that if the response model is used to evaluate off DOE data points, the predictive error is large. To determine the goodness of the predictive capability of the model throughout the entire space, one should select random cases, extract the response data, and calculate the error as was done with the model fit error distribution. A normal distribution exists for the MFE and MRE with nearly zero mean and less than one standard deviation. The actual by predict plot shows the perfect fit line and the distribution of the training cases and validation cases. This plot helps check if there is any cases do not fit well. The residual by predict plot shows the distribution of the errors for all cases and helps check where the maximum error occur [82].

Neural Network Fitting Results and Validation

To create database for surrogate generation, 17,000 data are generated by physics-based high fidelity modeling and simulation environment. The number of input parameters is 210. There are two outputs: Electrical Net Efficiency and Electrical Net Power.

Neural network modeling was performed in JMP 9.0 Pro[110], which is the commercial statistical package by SAS. The statistical metric of Electrical Net Efficiency and Electrical Net Power are shown in Table 2 and Table 8. The goodness of fit results of electrical net efficiency and electrical net power are shown in Figure 35, Figure 36, Figure 37 and Figure 38 respectively.

The coefficient of determination, also known as R^2 , indicates how well a regressed equation predicts the output for its training cases. This metric varies from 0 to 1, with a value of 1 representing a perfect fit. The R^2 for both the responses are 0.99, which means developed surrogated model can explain more than 99% of the data points.

The plot of actual training case versus neural network predicted values gives more detailed information about a surrogate model's quality. It gives an indicator as to how

Table 7 : Statistical Metric of Electrical Net Efficiency

Training		Validation	
ElectricalNetEfficiency	Measures	ElectricalNetEfficiency	Measures
RSquare	0.9931576	RSquare	0.9935824
RMSE	0.0415707	RMSE	0.0407131
Mean Abs Dev	0.0296239	Mean Abs Dev	0.0290959
-LogLikelihood	-19645.14	-LogLikelihood	-6626.468
SSE	19.273711	SSE	6.162797
Sum Freq	11153	Sum Freq	3718

well the neural network performs across the output space. It also allows for outliers to be identified and considered. For a good surrogate model, data points should fit tightly against the line of perfect fit, the 45 degree line across the plot where actual value equals predicted value. This can be seen in Figure 35 and Figure 37. Based on this plot, the 15 node surrogate model is deemed acceptable because of its low error throughout the design space.

The plot of neural network fitting error versus predicted value, also known as the residual vs. predicted plot, allows to gauge how much error exists in the neural network prediction for a given region of the output space. Figure 36 and Figure 38 show the residual versus predicted plots for efficiency and power. Clearly, a normal distribution does exist for Model Fit Error (MFE) and Model Representation Error (MRE) with nearly zero means and less than one standard deviation. Overall the surrogate model for each response predicts good accuracy.

Table 8 : Statistical Metric of Electrical Net Power

Training		Validation	
ElectricalNetPower	Measures	ElectricalNetPower	Measures
RSquare	0.9995869	RSquare	0.9995883
RMSE	0.4381894	RMSE	0.4318275
Mean Abs Dev	0.2536939	Mean Abs Dev	0.2507813
-LogLikelihood	6623.037	-LogLikelihood	2153.5005
SSE	2141.4873	SSE	693.31391
Sum Freq	11153	Sum Freq	3718

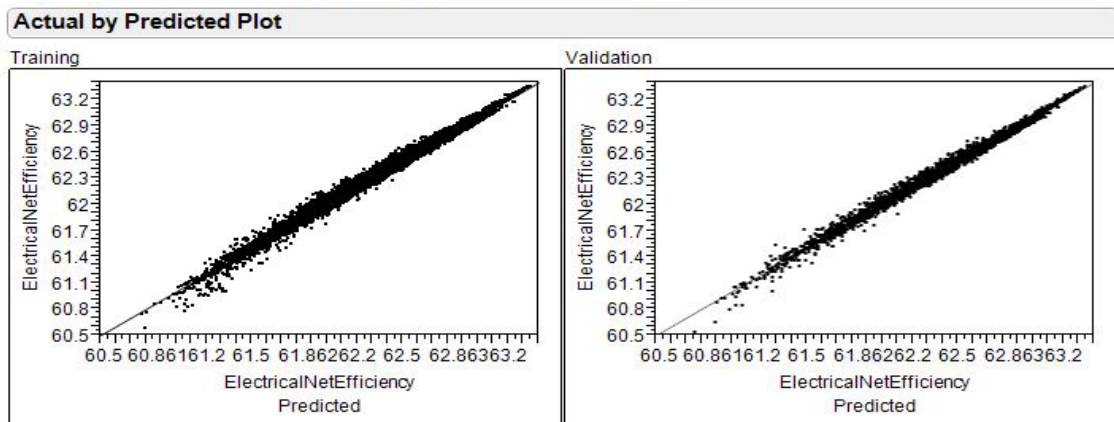

Figure 35. : Actual by Predicted Plot of Electrical Net Efficiency

Residual by Predicted Plot

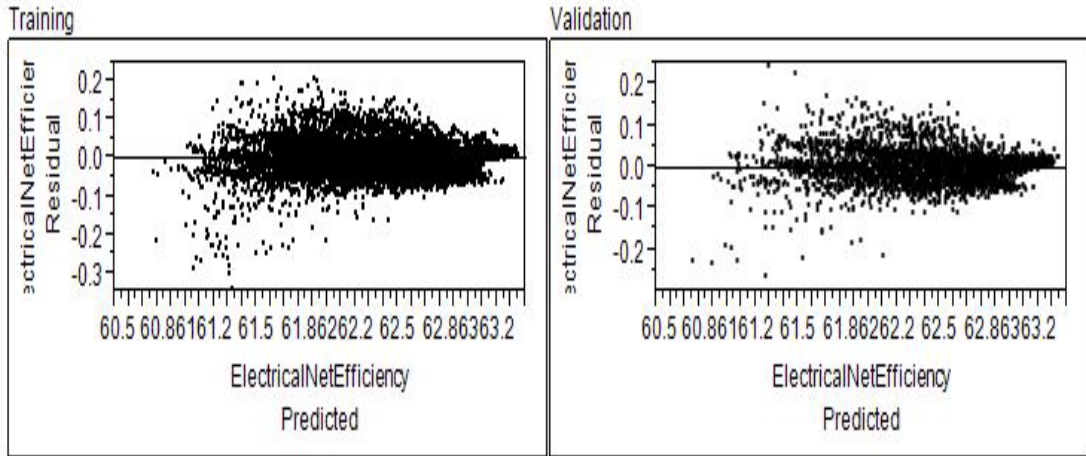

Figure 36. : Residual by Predicted Plot of Electrical Net Efficiency

Actual by Predicted Plot

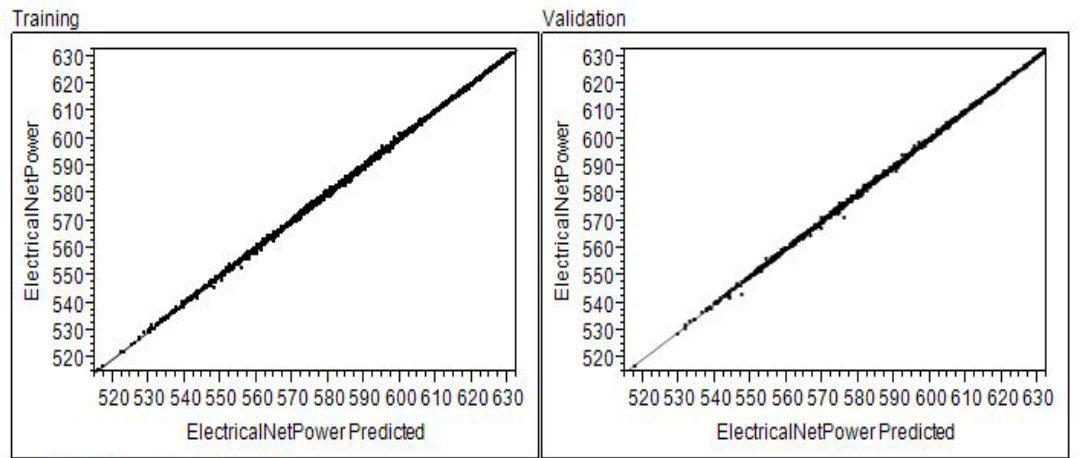

Figure 37. : Actual by Predicted Plot of Electrical Net Power

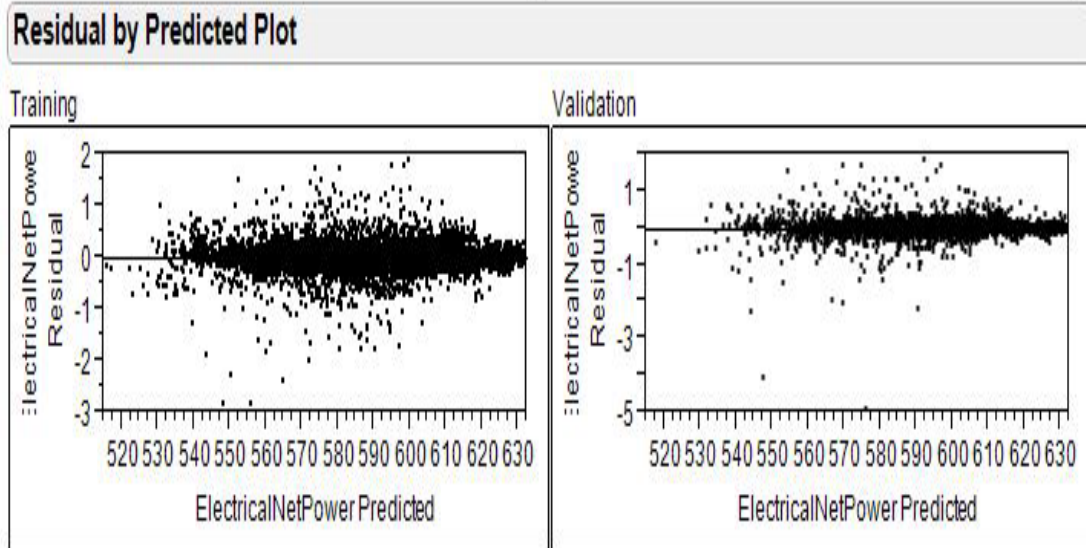

Figure 38. Residual by Predicted Plot of Electrical Net Power

Technology Modeling

Technologies are modeled with the help of k-factors and are recorded in Technology Impact matrices, technology compatibilities and technology synergy matrices. The detailed description of these matrices and interrelationships are discussed earlier in this study. Overall schematic representation of technology valuation process is shown in Figure 39.

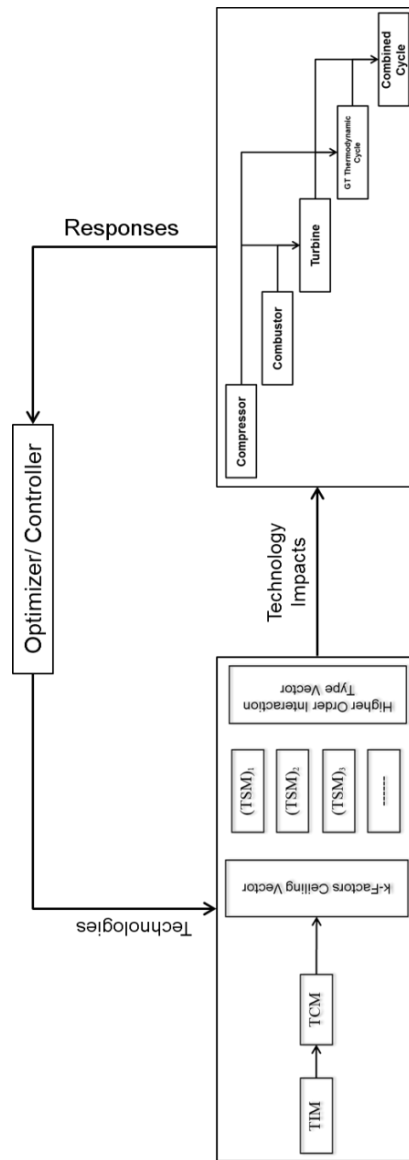

Figure 39. Integrated environment for technology valuation

Selected Technologies

Five technologies were selected out of a large pool of candidate technologies. These technologies were modeled and evaluated in integrated environment. These new technologies improve the combined cycle efficiency and power. As these are new technologies, the experts' opinions are elicited to quantify these impacts through disciplinary codes. The details, applicability and modeling of these technologies are discussed later in results' section.

Expert Elicitation

The potential impact caused by these technologies on the power generation system is recorded in the form of technology of technology impact matrix (TIM). The experts are asked to provide their assessment of the impact of the technology over the baseline. These impacts are then linked to input parameters of the disciplinary codes. Three types of responses are recorded for different studies:

- (a) Deterministic: Averaged response for deterministic valuation of technologies.
- (b) Interval: Minimum and maximum expected range in inputs without any associated distribution. The input may fall at any point inside the specified range. This is used for interval estimation.
- (c) Multiple intervals with associated basic probability assignments: These intervals are used for application of Dempster-Shafer theory of evidence. It can be noted that second and third type of expert elicitation is focused on epistemic uncertainty propagation.

In case of deterministic technology valuation, the experts are asked to provide the averaged impact of the technology on the system performance. Table 9 represents an

extract of technology impact matrix for one technology. Material systems technology impacts the heat conductivity of blades and vanes in different stages of gas turbine. These impacts, also known as k-factors, are listed in third column of Table 9. First column comprise of design metrics which are inputs to the disciplinary codes whereas second column shows the baseline values of the design metrics. New values of performance metrics are achieved by adding k-factors to baseline. K-factors can also be recorded in percentage or absolute format. In percentage format, the k-factors are multiplied with baseline values to get the updated performance improvements, whereas in absolute format, the value of baseline is replaced by the value of k-factor. Similarly values of heat conductivity for other blades and vanes can be calculated. These updated values are used and input parameters of design codes to quantify the system level improvements.

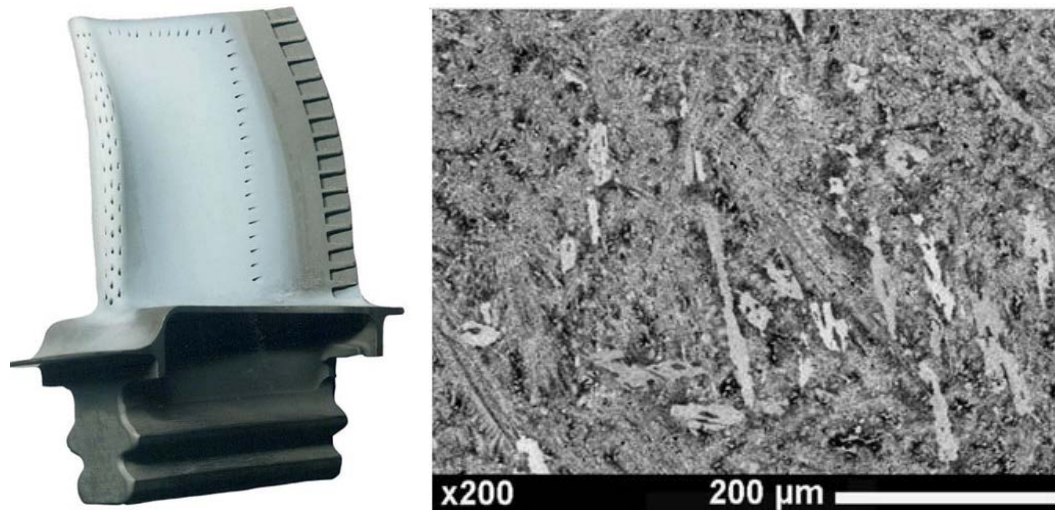

Figure 40: Material Systems Technology [111]

Table 9: Deterministic Technology Impacts of Material Systems

Technology

Variable Name [W/(m ² *K)]	k-factors for Material Systems Technology
Hcv1	0.21
Hcv2	0.225
Hcv3	0.255
Hcv4	0.355
Hcb1	0.175
Hcb2	0.185
Hcb3	0.355
Hcb4	0.355

For interval analysis, the elicitation consists of obtaining the minimum and maximum values of intervals.

Table 10 shows the minimum and maximum bounds of intervals on input parameters for impact of material systems technology. These inputs are then used to perform interval analysis. In Table 10 first column contains the variable names, which are the inputs to the disciplinary codes. Second and third columns represent the improvement over the baseline due to the technology. The intervals assigned by the experts have minimum and maximum values without assigning any distribution to them. It is assumed that no other information is available, except the range of the interval. These intervals can be assigned in form of percentage or absolute value. In Table 10, the heat conductivity for vane 1 (Hcv1) would have the new absolute range by adding the k-factor with the baseline to get a lower bound and upper bound. In case of percentage improvement format of technology impact matrix, same values will act as multiplication factors.

Table 10: Technology Impacts of Material Systems Technology

Variable Name [W/(m ² *K)]	Intervals	
	Min	Max
Hcv1	0.168	0.252
Hcv2	0.180	0.270
Hcv3	0.204	0.306
Hcv4	0.284	0.426
Hcb1	0.140	0.210
Hcb2	0.148	0.222
Hcb3	0.284	0.426
Hcb4	0.284	0.426

In case of Dempster-Shafer theory of evidence, the input variables of disciplinary codes are modeled as sets of intervals. Each interval has associated basic probability assignment (BPA) which indicates the likelihood of that value of the input to fall with that interval. Data from

Table 11 to Table 14 represents the technology impact factors for Dempster Shafer theory of evidence. These tables show the technology impacts for heat conductivities for vane 1, vane 2, blade 1 and blade2. Material systems technology also effect thermal conductivities of vane 3, vane 4, blade 3 and blade 4. Each table has impact factors for one input parameter. These impact factors are divided into multiple intervals. These intervals are shown in second and third columns. Associated basic probability assignments for respective rows are shown in the last column. In

Table 11 it can be observed that improvement in heat conductivity of vane 1 is divided into 5 intervals. First interval has its bounds in between 0.179 and 0.189 with associated basic probability assignment of 0.3. It means that according to the expert there is 30 percent likelihood that value of heat conductivity of vane 1 will fall within this

interval. Similarly interval bounds and associated basic probability assignments for other intervals can be seen in the table.

Table 11: Technology Impact for Heat Conductivity of Vane 1 for Evidence Theory

Interval #	Interval Bounds [W/(m²*K)]		BPA's
1	0.179	0.189	0.3
2	0.189	0.200	0.2
3	0.200	0.210	0.1
4	0.210	0.221	0.3
5	0.231	0.242	0.1

Table 12: Technology Impact for Heat Conductivity of Vane 2 for Evidence Theory

Interval #	Interval Bounds [W/(m²*K)]		BPA's
1	0.191	0.203	0.3
2	0.203	0.214	0.5
3	0.248	0.259	0.2

Table 13: Technology Impact for Heat Conductivity of Blade 1 for Evidence Theory

Interval #	Interval Bounds [W/(m²*K)]		BPA's
1	0.149	0.158	0.1
2	0.158	0.166	0.2
3	0.166	0.175	0.2
4	0.184	0.201	0.5

Table 14: Technology Impact for Heat Conductivity of Blade 2 for Evidence Theory

Interval #	Interval Bounds [W/(m²*K)]		BPA's
1	0.157	0.176	0.4
2	0.185	0.194	0.5
3	0.194	0.213	0.1

The intervals of the input parameters can be adjacent, overlapping or disjoint. It can be observed that all intervals are adjacent for heat conductivity of blade 2. Heat conductivity of vane 2 has first two intervals are disjoint whereas last interval is adjacent. The number, bounds and basic probability assignments of the intervals impact the shape of resulting cumulative belief and plausibility function.

Uncertainty propagation

Epistemic uncertainty in technology valuation process is quantified by interval estimation and Dempster-Shafer theory of evidence. For comparison of results averaged deterministic valuation is also performed.

Deterministic

Deterministic technology valuation is based on averaged technology impacts and serves as a sanity check for the results obtained from interval analysis and Dempster-Shafer theory of evidence. In this method the averaged technology impacts are propagated through the modeling and simulation environment and single point objectives are obtained.

Interval Analysis

The interval analysis is performed with the assumption that the only available information about a set of variables is their minimum to maximum range. No other information is available. When this set is propagated to outputs through the analysis, the ranges on the outputs are obtained. The output ranges have the same characteristic as that of input ranges. The output ranges does not have any associated distribution.

Two approaches can be employed for interval analysis:

- (a) Sampling based uncertainty analysis
- (b) Optimization based interval analysis

Latin Hypercube sampling (LHS) is employed for sampling based uncertainty quantification. LHS sampling is computationally slightly less expensive than traditional Monte Carlo (MC) approach [112-115].

For optimization based interval analysis, efficient global optimization (EGO) technique is employed. In EGO, the objective function is estimated through Gaussian approximation from sample points of true function. Expected Improvement Function (EIF) looks for the better objective function in the search space. Efficient global optimization tries to maximize the EIF [116, 117]. This technique was initially developed to calculate the unconstrained minimization of implicit response functions, which are computationally very expensive. This approach is very effective and use true functions to

evaluate the function minimum and very few Gaussian Process samples are used to calculate the function maximum. The efficiency of this process depends on nonlinearity of the simulation model and the input dimensions.

Dempster Shafer Theory of Evidence

Dempster-Shafer theory of evidence combines the input variable intervals in the form of an input cell. Each interval of a variable are combined with intervals of other variables, thus creating a set of combinations. Minimum and maximum values of each interval cell are calculated. The aggregation of these values creates belief and plausibility curves. It is obvious that in case of more variables the number of input cells would increase rapidly, thus making implementation of Dempster-Shafer theory of evidence very expensive. Surrogate modeling can alleviate this problem by enabling very fast function calls.

CHAPTER 7

RESULTS AND DISCUSSIONS

In this section results from different approaches for uncertainty analysis are discussed. Interval analysis and Dempster-Shafer theory of evidence were used to propagate the uncertainty.

Interval Analysis

Interval analysis was performed by sampling-based and optimization approaches. As mentioned in the previous section, Latin Hypercube methodology was applied for sampling-based interval analysis. For interval analysis, only one interval per input variable can be assigned. Simulations were performed with 1000, 5000, 10000 and 100000 sample sizes. The results were similar between 10,000 and 100,000 sample sizes, so sample size of 10,000 was selected for further simulation. In Table 15, results for sampling-based interval analysis of material systems technology are shown. Lower and upper bounds are calculated for efficiency and power improvements.

Table 15 : Results for Interval Analysis

	Δ Efficiency (%)		Δ Power (MW)	
	Lower Bound	Upper Bound	Lower Bound	Upper Bound
Sampling	0.1884	0.3157	13.3451	22.3981
Optimization	0.1887	0.3157	13.3452	22.3981

Optimization was also used to perform interval analysis. Efficient global optimization (EGO) was employed for global optimization to calculate the bounds. As mentioned earlier in the document this is based on Gaussian process surrogate. This

technique is very effective as far as function calls are concerned. It used only 57 function evaluations to calculate the minimum and maximum estimates of efficiency improvements. A comparison of the results obtained from sampling and optimization base interval analysis is shown in Table 15.

Dempster-Shafer Theory of Evidence

Dempster-Shafer theory of evidence is used in this study to characterize epistemic uncertainty. Unlike interval analysis, Dempster-Shafer theory of evidence allows use of multiple intervals and associated basic probability assignments (BPA) for each input. Belief structure on two intervals is shown below. The values of these variables are normalized from 0.85 to 1.15. Belief structures are also shown in graphical and tabular form.

Input Variable 1:

Number of intervals = 5

interval_probabilities = 0.3 0.2 0.1 0.3 0.1

interval_bounds = 0.85 0.90 0.90 0.95 0.95 1.00 1.00 1.10 1.10 1.15

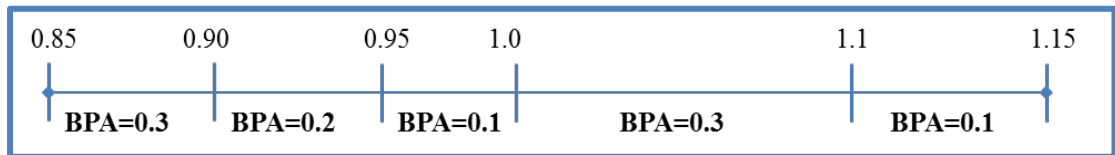

Figure 41: Intervals and Associated BPAs for Evidence analysis

Table 16: Intervals and Associated BPAs for Evidence analysis

	Interval Bounds		BPA's
1	0.85	0.90	0.3
2	0.90	0.95	0.2
3	0.95	1.00	0.1
4	1.00	1.10	0.3
5	1.10	1.15	0.1

Input Variable 2:

Number of intervals = 3

interval_probabilities = 0.5 0.3 0.2

interval_bounds = 0.85 0.90 0.90 1.00 1.05 1.15

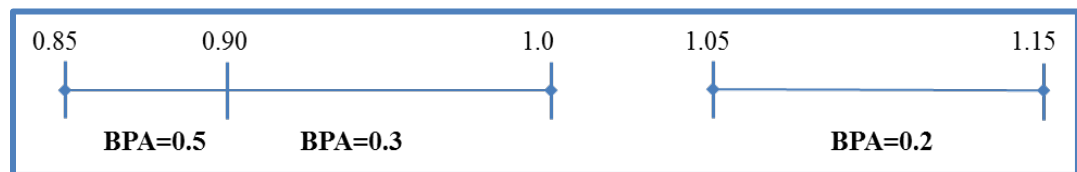

Figure 42: Intervals and Associated BPAs for Evidence analysis

Table 17: Intervals and Associated BPAs for Evidence analysis

	Interval Bounds		BPA's
1	0.85	0.90	0.5
2	0.90	1.00	0.3
3	1.05	1.15	0.2

Cumulative Belief and Plausibility Distributions (CBF, CPF)

Figure 43 shows the cumulative belief function (CBF) and cumulative plausibility function (CPF) for efficiency improvement. This is similar to cumulative distribution

function (CDF). CBF is the cumulative belief that uncertain variable \tilde{x} is less than a given value of x . Similarly CPF represent the cumulative plausibility that uncertain variable \tilde{x} is less than a given value of x . CBF and CPF are denoted as $\text{Bel}(\tilde{x} \leq x)$ and $\text{Pl}(\tilde{x} \leq x)$ respectively. In Figure 4, it can be seen that cumulative belief that efficiency improvement is less than or equal to 0.28% is 0.5 and cumulative plausibility that efficiency improvement is less than or equal to 0.28% is 0.7.

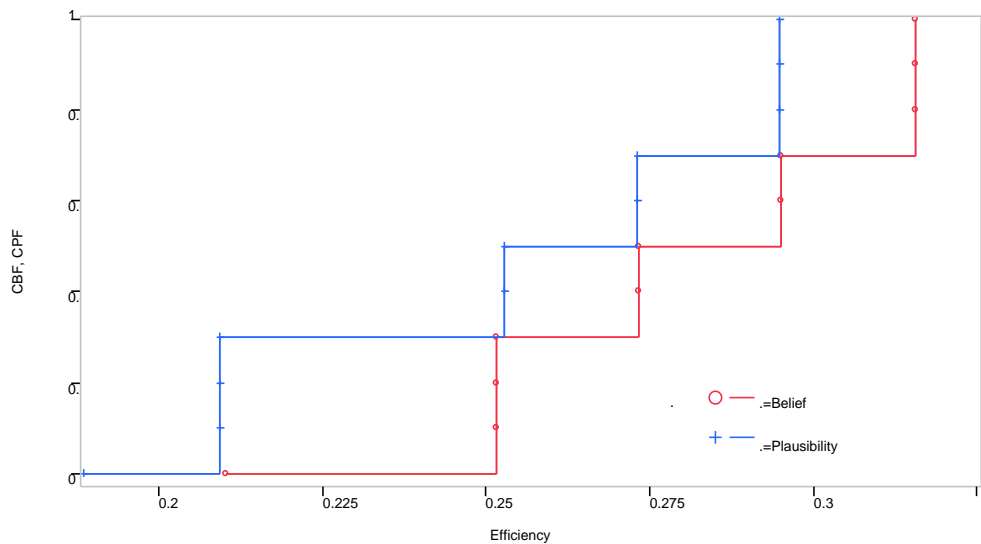

Figure 43. Cumulative Belief and Plausibility Distributions [$\text{Bel}(\tilde{x} \leq x)$, $\text{Pl}(\tilde{x} \leq x)$] for Efficiency Improvement

Complementary Cumulative Belief and Plausibility Distributions (CCBF, CCPF)

Complementary cumulative belief function and complementary cumulative plausibility function are an alternate presentation of CBF and CPF. The Complementary cumulative functions for belief and plausibility are shown in Figure 44 for efficiency improvements respectively. Complementary cumulative belief function is the cumulative belief that the uncertain value \tilde{x} is greater than a given value x . Similarly complementary

cumulative plausibility function is the cumulative plausibility that the uncertain value \tilde{x} is greater than a given value x . They are generally written as $\text{Bel}(\tilde{x} > x)$ or $\text{Pl}(\tilde{x} > x)$. In Figure 44 it can be seen that complementary cumulative belief that efficiency improvement is more than 0.26% is 0.5 whereas complementary cumulative plausibility that efficiency improvement is more than 0.26% is 0.7. These plots also show the deterministic results and interval estimation outputs.

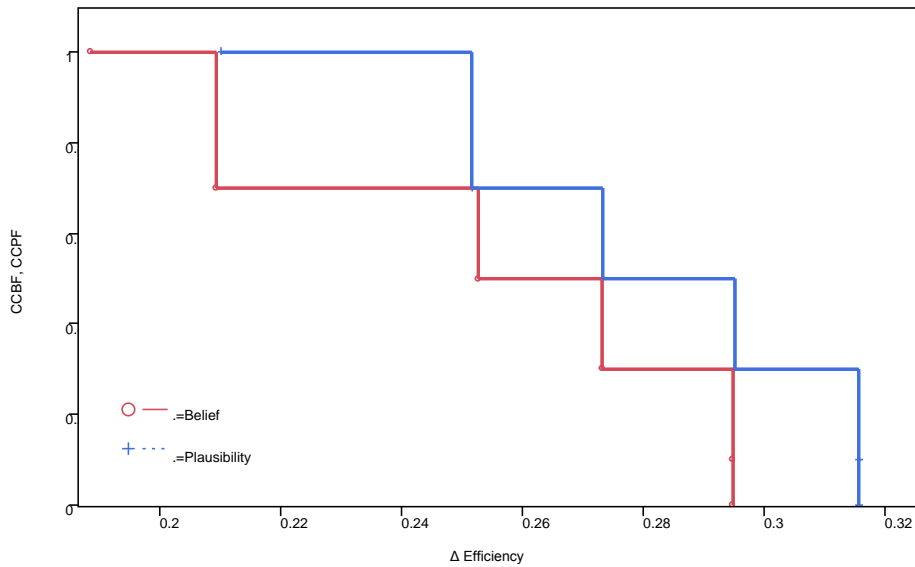

Figure 44. Cumulative Belief and Plausibility Distributions [$\text{Bel}(\tilde{x} > x)$ or $\text{Pl}(\tilde{x} > x)$] for

Impact of Input Intervals Settings on Response Distributions

Figure 45 represent results from a portfolio of technologies with five technologies. This plot represent two sets of the complementary cumulative belief function (CCBF) and complementary cumulative plausibility function (CCPF) for power. It can be observed that due to high numbers of input intervals, the large numbers of

output intervals were created. This resulted in the CCBF and CCPF curves with fine steps.

A comparison is also made to assess the impact of different configurations of intervals within the same extreme minimum and maximum values in Figure 45. It can be observed that Belief_2 and Plausibility_2 have coarser intervals and thus producing bigger step sizes. This can result in possible loss of accuracy between larger steps. The more information about inputs will yield more accurate representation of output belief and plausibility representation. Similar behavior can also be seen from coarser to finer distribution curves with addition of more uncertain variables in the analysis.

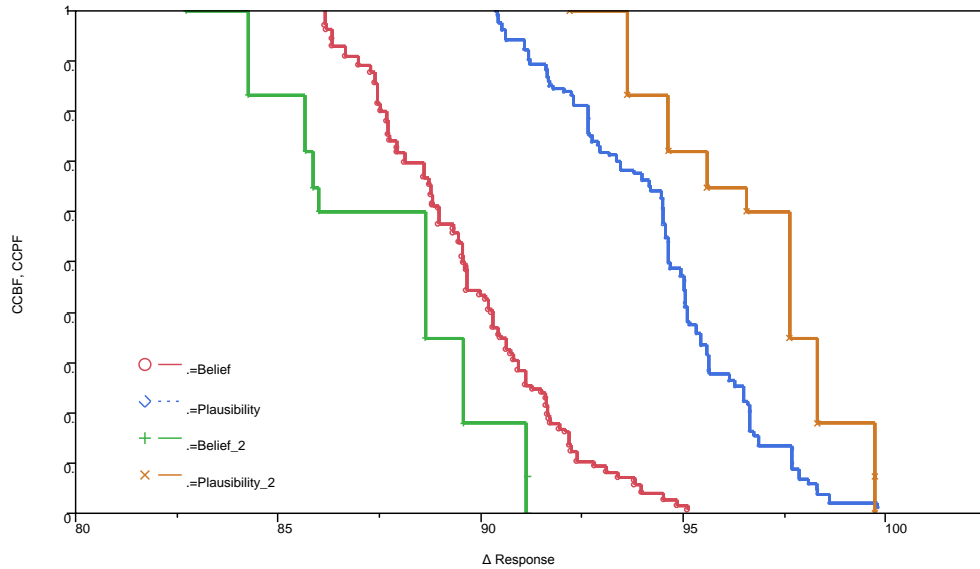

Figure 45. Comparison between different interval settings: Complementary Cumulative belief and plausibility distributions [Bel($\tilde{x} > x$) or Pl($\tilde{x} > x$)] for Power Improvement

Uncertainty Quantification through DAKOTA

DAKOTA (Design and Analysis toolkit for Optimization and Terascale Applications) support advanced methods for optimization, sensitivity analyses, parameter estimation and uncertainty quantification[118, 119]. It provides an automated iterative analysis capable of handling uncertainty quantification, parameter estimation, optimization and sensitivity analysis. A generic top level schematic for DAKOTA is shown in Figure 39. It works well as a non-intrusive and semi-intrusive process as regard to computational model. This is a very desirable functionality that allows seamless integration of DAKOTA with the engineering modeling and simulation codes.

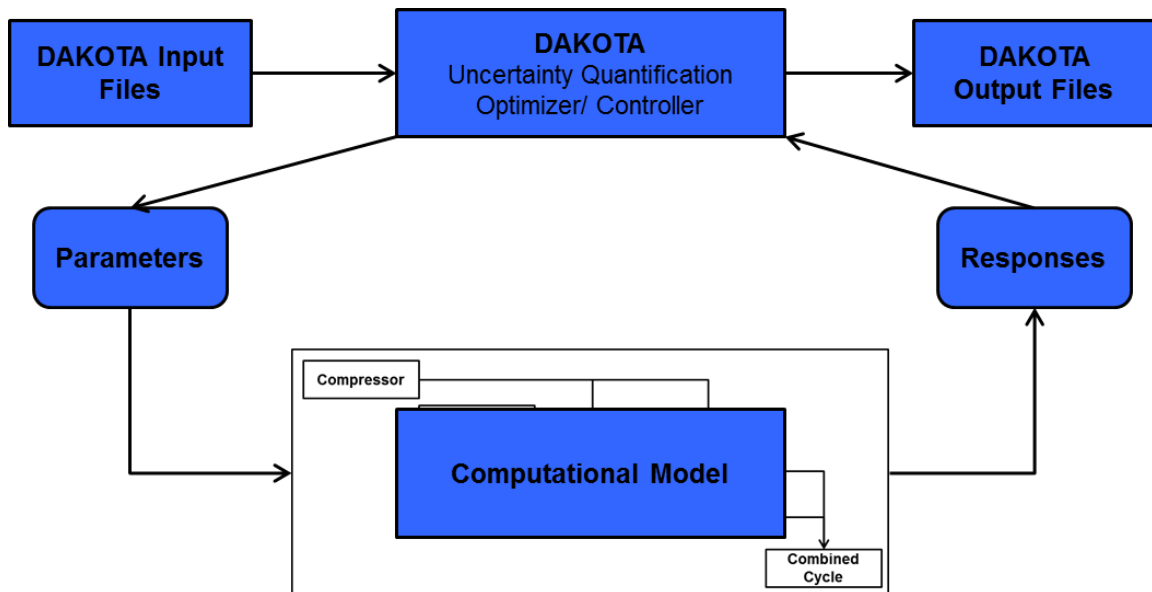

Figure 46. DAKOTA setup for automated iterative analysis

DAKOTA system revolves around five main components including strategy, method, model, variables, interface and responses. The strategy commands provide a high level control layer for management of multiple iterators.

Main types of strategies include single method, hybrid, multi-start and pareto set. In single method, a single iterator is used with one method. It is the used when multiple iterators are not required. Hybrid strategy is used when various optimization/ minimization algorithms are used at various phases of the process. This method exploits strengths of different techniques at appropriate stage of the process for maximum efficiency. The multi-start iteration strategy allows the start of code from multiple values of design variables concurrently. A common use of this strategy is multi-start local optimization, which can help to achieve optimal solution in a more robust manner. Pareto set optimization strategy performs iterations by assigning different weights to multiple objective functions. It results in a Pareto set, which is then used for trade-offs between competing objectives. This strategy can perform parallel iterations. In present study a single strategy is used for interval analysis and Dempster-Shafer theory of evidence. The examples of single method, hybrid, multi-start and pareto set strategies are as following:

```
strategy,  
    single_method  
    method_pointer = 'UQ1'  
  
strategy,  
    hybrid sequential  
    method_list = 'GA', 'PS', 'NLP'
```



```
strategy,  
    multi_start  
    method_pointer = 'NLP'  
    random_starts = 20  
  
strategy,  
    pareto_set  
    method_pointer = 'NLP'  
    random_weight_sets = 15
```

Strategy selection is followed by a method section which specifies the description, and controls of an iterator. A selection is made from the available options including uncertainty quantification, optimization, least squares, design of experiments, and parameter study iterators according to the requirement of the problem. These iterators are accompanied by the method specific controls which change according to the specific method. An example is shown below where epistemic uncertainty analysis is performed through Dempster-Shafer theory of evidence. Here sampling is used to calculate the interval bounds. It can also be defined to be performed by global optimization approach. Number of samples and details about required output are also specified in the method section.

```
method
id_method = 'UQ1'
model_pointer = 'UQ1'
nond_global_evidence lhs
    samples = 10000
    seed = 59334 rng rnum2
response_levels = 60.80 61.50 62.00 62.50 63.50 518.0 525.0 535.0 600.0
probability_levels = 0.1 0.25 0.5 0.75 1.0 0.1 0.25 0.5 1.0
distribution cumulative
output verbose
```

Following method applies to interval analysis for epistemic uncertainty. Interval analysis can either be performed with local or global methods. In case of local method sequential quadratic programming (SQP) or nonlinear interior point (NIP) can be used. In global approach for the interval analysis either a sampling or a global optimization approach can be used. In present study both the approaches were tested. For sampling based global approach Latin Hypercube Sampling (LHS) was applied, which takes the minimum and maximum samples as the bounds. For optimization based global approach the efficient global optimization (EGO) is used to determine the bounds

```
method
    id_method = 'INT1'
    model_pointer = 'INT1'
    nond_global_interval_est lhs
    samples = 10000
```

In the following examples Gauss-Newton algorithm is used for optimization with associated method specific control settings.

```
method,
    optpp_g_newton
    max_iterations = 15
    convergence_tolerance = 1.e-10
    search_method trust_region
    gradient_tolerance = 1.e-4
```

Vector parameter study is used to study the response along a vector in parameter space. It is implemented by further specifying final points and number of steps.

```
method,  
    vector_parameter_study  
    final_point = 5.1 7.3  
    num_steps = 10
```

Method specification in DAKOTA input file is followed by model description. Model contains the controls that describe how input parameters are mapped to their responses in an iterative process. Model lists down the components necessary to construct a particular model instance under a method. There are four main classes of models named as single, data fit surrogates, hierarchical approximations, and nested model. Based on the specific class, additional model specific controls are also specified. An example of single class model is shown below. Model independent controls include a model identifier which is used to categorize a particular model within method specifications. Variable and response pointers are used to identify the unique sets required to be used with the specific models. If only one set of models, variables and responses are present then their respective pointers can be omitted.

```
model  
    id_model = 'UQ1'  
    variables_pointer = 'variablesForUQ1'  
    responses_pointer = 'forUQ1'  
    single
```

aleatory uncertainty.

Parameters for the analyses are defined in the variable section. These variables can be design, state and uncertain variables. Design variables are used in optimization where their values are adjusted to reach to optimal solution. These variables can be continuous or discrete. They can also have an initial point and a descriptive tag. In case of ranges they can be defined with lower and upper bounds. For discrete sets some admissible values are assigned to each variable.

Uncertain variables are used when deterministic value of the variable is not known or when the analysis is aimed at quantification of uncertainty. They can be categorized as aleatory or epistemic variables. Aleatory uncertainties are irreducible and generally have sufficient data points that facilitate in defining the appropriate probability distributions. A continuous aleatory uncertain variable can be described by normal, lognormal, uniform, loguniform, triangular, exponential, beta, gamma, gumbel, frechet, weibull or histogram bin distribution. Similarly discrete aleatory variables can have Poisson, Binomial, Negative Binomial, Geometric, Hypergeometric, or Histogram Point probability distributions. Each type of distribution has different controls for their respective variables. Epistemic uncertainties are inherently reducible and assume very little knowledge about the problem. Epistemic uncertain variables are characterized by intervals with lower and upper bounds with associated basic probability assignments (BPAs).

State variables are the ones which are mapped through the simulation. They are additional model inputs which are neither design variables nor they are uncertain. They are important because they bring adaptability in the system and can be used for some advanced parametric study in future. State variables can be continuous or discrete. State variables are not used by uncertainty quantification, optimization or other algorithms.

Design of experimental methods and parameter study techniques use the state variables and their impact on the system performance can be measured.

Following example three continuous design variables are defined with an initial point followed by lower and upper bounds.

```
variables,  
continuous_design = 3  
initial_point 100.5 110.5 125.3  
upper_bounds 120.5 125.6 132.4  
lower_bounds 90.3 97.4 105.2  
descriptors 'X1' 'X2'
```

Uncertain variables with number of uncertain intervals, applicable bounds and associated basic probability assignments are shown in this example:

```
variables  
id_variables = 'variablesForUQ1'  
interval_uncertain = 5  
num_intervals = 3 3 2 2 2  
interval_probs = 0.3 0.4 0.3 0.4 0.3 0.4 0.4 0.6 0.6 0.4 0.7 0.3  
interval_bounds = 0.85 0.95 0.95 1.05 1.05 1.15 0.85 0.95 0.95 1.05  
1.05 1.15 0.85 0.95 0.95 1.15 0.85 1.0 1.0 1.15 0.85 1.05 1.05 1.15  
descriptors = 'X1' 'X2' 'X3' 'X4' 'X5'
```

Following example include design, uncertain, and state variables. Different classes of these variables are also shown in the same example.

```
variables,  
id_variables = 'VarAll'  
    continuous_design = 3  
        initial_point 100.5 110.5 125.3  
        upper_bounds 120.5 125.6 132.4  
        lower_bounds 90.3 97.4 105.2  
        descriptors 'X1' 'X2'  
    discrete_design_range = 1  
        initial_point 150  
        upper_bounds 200  
        lower_bounds 100  
        descriptors 'X3'  
    normal_uncertain = 2  
        means = 200.2, 350.1  
        std_deviations = 10.3, 25.2  
        descriptors = 'X4' 'X5'  
    uniform_uncertain = 2  
        lower_bounds = 100.5, 230.2  
        upper_bounds = 540.3, 650.2  
        descriptors = 'X6' 'X7'
```



```
continuous_state = 2
    initial_state = 1.e-4 1.e-6
    descriptors = 'CC1' 'CC2'
discrete_state_set_int = 1
    initial_state = 50
    set_values = 50 100 150
    descriptors = 'CS1'
```

Interface section is responsible for control on how function evaluations will be performed for mapping input parameters to responses. Function evaluations are executed by interfaces to simulation codes or algebraic mappings. When the interfaces to simulation codes are used, the function evaluations are done through direct function invocation, system calls, or forks. If the simulation is linked to DAKOTA, the direct function interface can be used to invoke it. This interface improves the computational effort involved in the process creation and file operations. To implement this interface existing simulations codes need to be converted into library with a subroutine interface. The system call simulation interface involves creation of a process that communicates with DAKOTA algorithms through a setup of parameter and response files. Although this process necessitates the creation of extra setup for files creation, but have an advantage of using simulation code in non-intrusive way. This allows the use of simulation code without any major change. The fork interface works like system interface and uses the external file system to manage the simulation code. It utilizes fork, exec, and wait function families. An example each from system and the direct function interface is shown below.

```

interface
    analysis_drivers = '/share/script'
system
    parameters_file = 'pr'
    results_file = 'rs'
    file_tag
    file_save
asynchronous
evaluation_concurrency = 100

interface,
    direct
        analysis_driver = 'textbook'

```

The responses section in input file controls the behavior of output from execution of the simulation code in DAKOTA. The specification comprises of number and type of response functions. It can also contain first and second derivatives for the response functions. In case of optimization methods, number of objective functions, and number of nonlinear equality and inequality constraints are utilized. For least square data set number of least square terms, and number of nonlinear equality and inequality constraints are appropriate. Finally number of response functions are used in case of uncertainty quantification methods. Following example shows a response specification for uncertainty quantification case. There is no gradient or Hessian availability.

```
responses
    id_responses = 'forUQ1'
descriptors = 'Elect_Eff' 'Elect_Power'
num_response_functions = 2
no_gradients
no_hessians
```

Following examples show generic responses section for optimization and least squares data set.

```
responses,
num_objective_functions = 1
num_nonlinear_inequality_constraints = 3
analytic_gradients
no_hessians

responses,
num_least_squares_terms = 5
numerical_gradients
method_source dakota
interval_type central
fd_gradient_step_size = .001
no_hessians
```

Input files for interval analysis with sampling and EGO methods were created and simulations were carried out. Similarly input files for evidence theory were generated and results were analyzed. Selected extracts of input files and results are reproduced in Appendix ‘A’ and ‘B’ respectively.

Combined Results: Individual Technologies/ Portfolios

Results from individual technologies and portfolios are presented in the following section. These results represent treatment of epistemic uncertainty through interval analysis and Dempster-Shafer theory of evidence. The results also include deterministic values of respective responses for comparison purposes.

TECH01: Advanced Burner Concept

The Advanced burner concept is aimed at improving the performance of combustors [120]. Advanced burner stabilization methods allow quick adjustments to the requirements [121]. This technology also target better design process, and improved controls. This results in better emission levels.



Figure 47: Advanced Burner Concept [122]

For interval analysis, percent of mixed fuel (F_u) is assigned the normalized interval $[0.85, 1.15]$. Similarly input intervals for Dempster-Shafer theory of evidence were assigned in the format shown in Figure 41 and Figure 42. The resulting complementary cumulative functions for belief and plausibility (CCBF, CCPF) are shown in Figure 48 and Figure 49 for efficiency and power respectively. It also shows the deterministic results and ranges of interval estimation outputs.

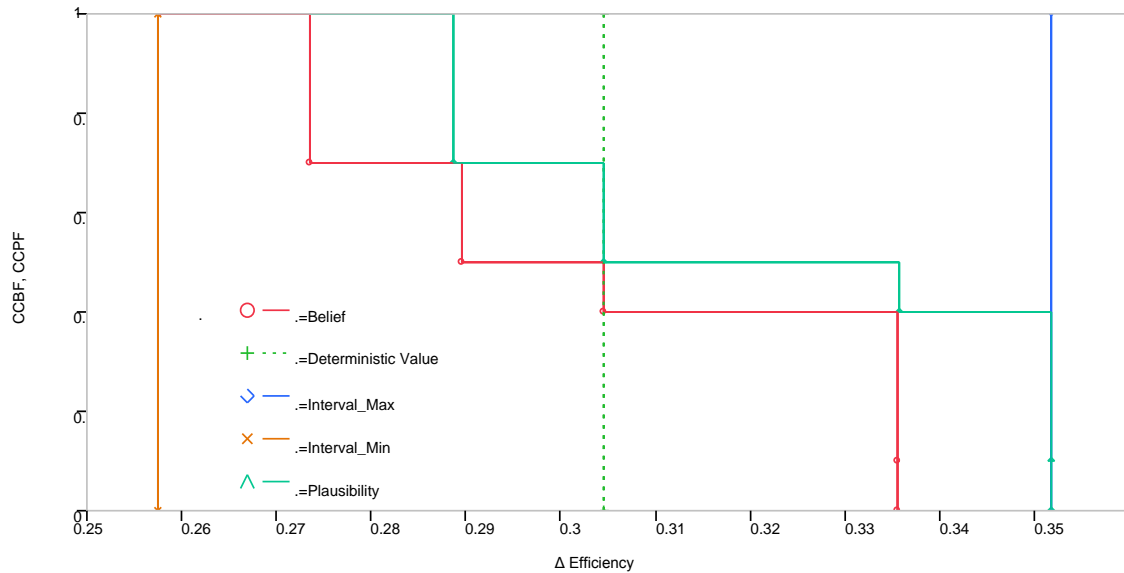

Figure 48. Uncertainty Propagation in Technology Valuation for TECH01: Plots of CCBF and CCPF [Bel ($\tilde{x}>x$) or Pl($\tilde{x}>x$)] for Efficiency

As discussed earlier, complementary cumulative belief function is the cumulative belief that the uncertain value \tilde{x} is greater than a given value x , and complementary cumulative plausibility function is the cumulative plausibility that the uncertain value \tilde{x} is greater than a given value x . They are generally written as $\text{Bel}(\tilde{x}>x)$ or $\text{Pl}(\tilde{x}>x)$. In Figure 48 it can be seen that complementary cumulative belief that efficiency improvement is more than 0.32% is 0.4 whereas complementary cumulative plausibility that efficiency improvement is more than 0.32% is 0.5.

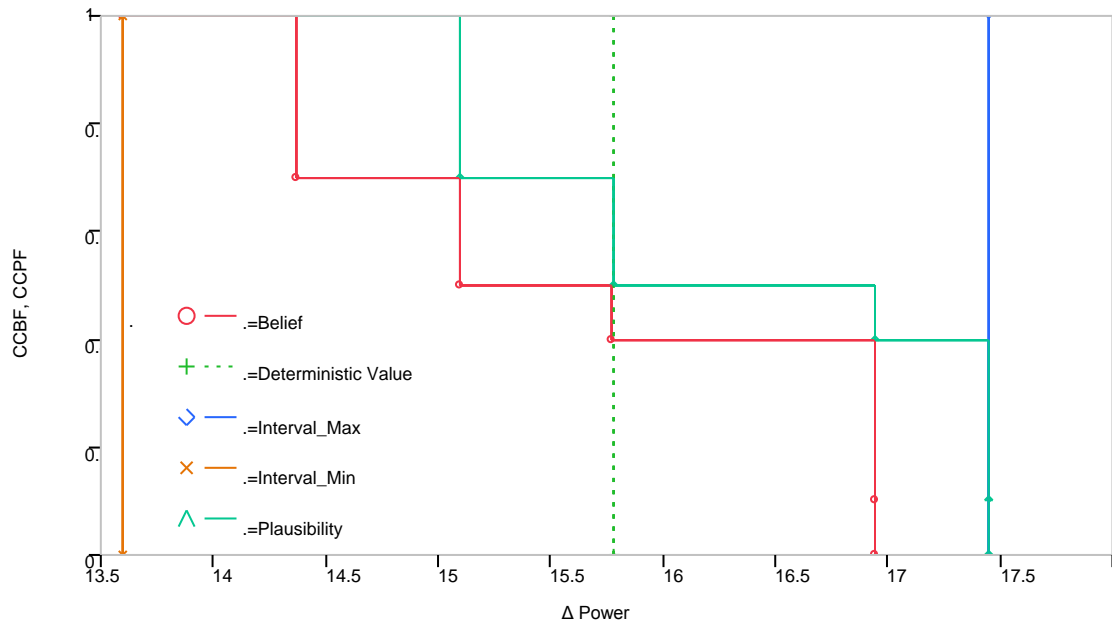

Figure 49. Uncertainty Propagation in Technology Valuation for TECH01: Plots of CCBF and CCPF [Bel($\tilde{x}>x$) or Pl($\tilde{x}>x$)] for Power

TECH07: Compressor performance improvement

This technology improves the compressor polytropic efficiency. The improvement in compressor polytropic efficiency is denoted by E_p .

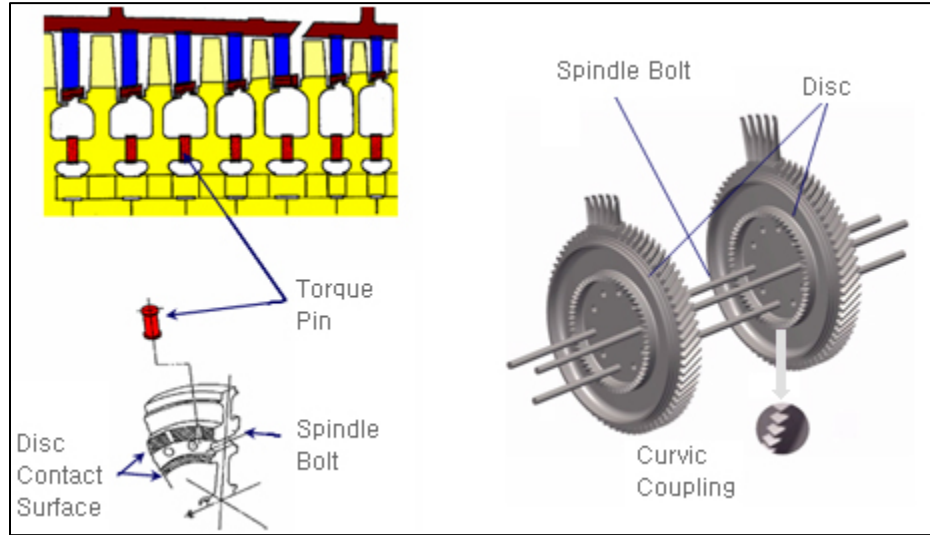

Figure 50: Compressor Performance Improvement [123]

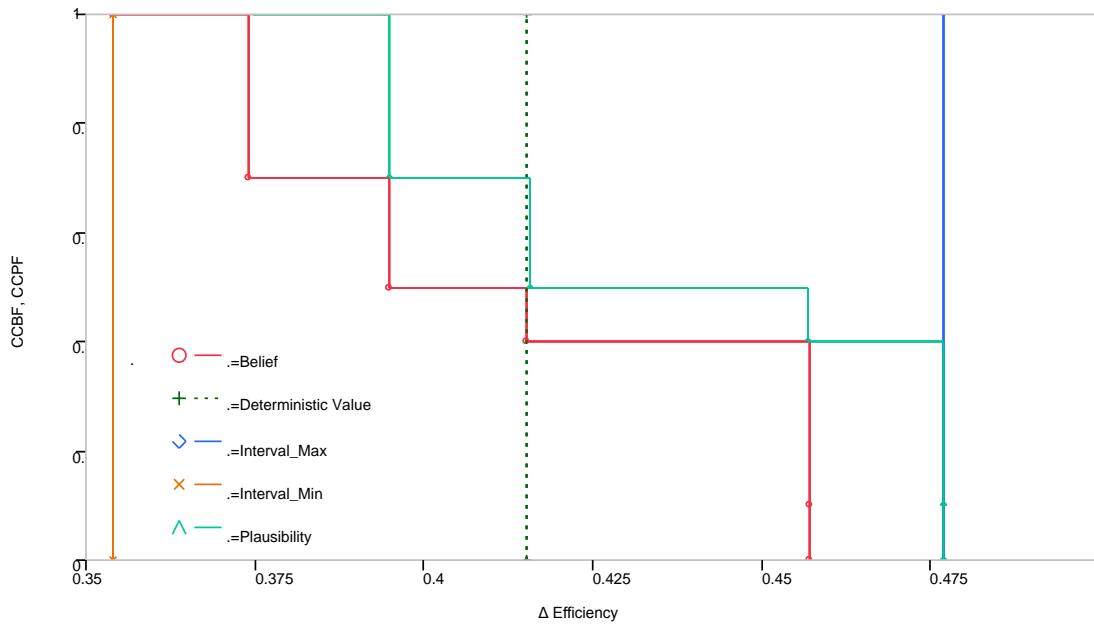

Figure 51. Uncertainty Propagation in Technology Valuation for TECH07: Plots of CCBF and CCPF [Bel($\tilde{x}>x$) or Pl($\tilde{x}>x$)] for Efficiency

For interval analysis, E_p is assigned the normalized interval [0.85, 1.15] whereas for deterministic analysis normalized value of E_p was set to 1. For application of Dempster- Shafer theory of evidence, the belief structure on F_u was assigned in the similar format shown in Figure 41 and Figure 42. The resulting complementary cumulative functions for belief and plausibility (CCBF, CCPF) are shown in Figure 51 and Figure 52. It also shows the deterministic results and interval estimation outputs.

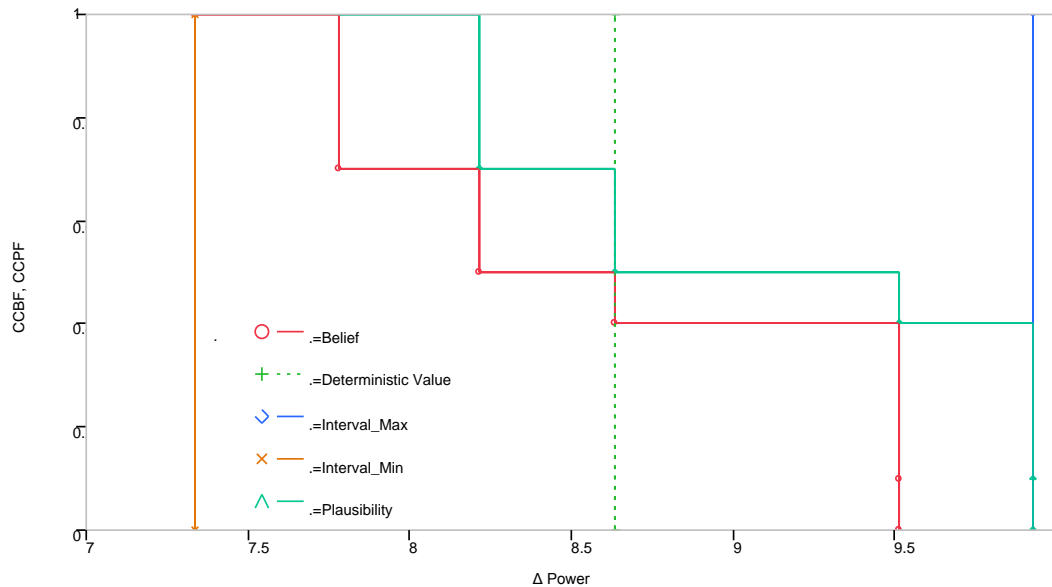

Figure 52. Uncertainty Propagation in Technology Valuation for TECH07: Plots of CCBF and CCPF [Bel ($\tilde{x}>x$) or Pl($\tilde{x}>x$)] for Power

TECH16: Turbine cooling system improvement

This technology improves overall performance of gas turbine. It offers an improved system of cooling of the hot section components in a gas turbine. This

technology includes a turbo-compressor and two heat exchangers [124]. The inlet of the heat exchanger is in fluid contact with the low temperature discharge air from engine compressor booster section. The outlet of the first heat exchanger is in fluid contact with second heat exchanger which is further connected to turbo-compressor. The turbo-compressor is finally connected to the portions of engine requiring cooling.

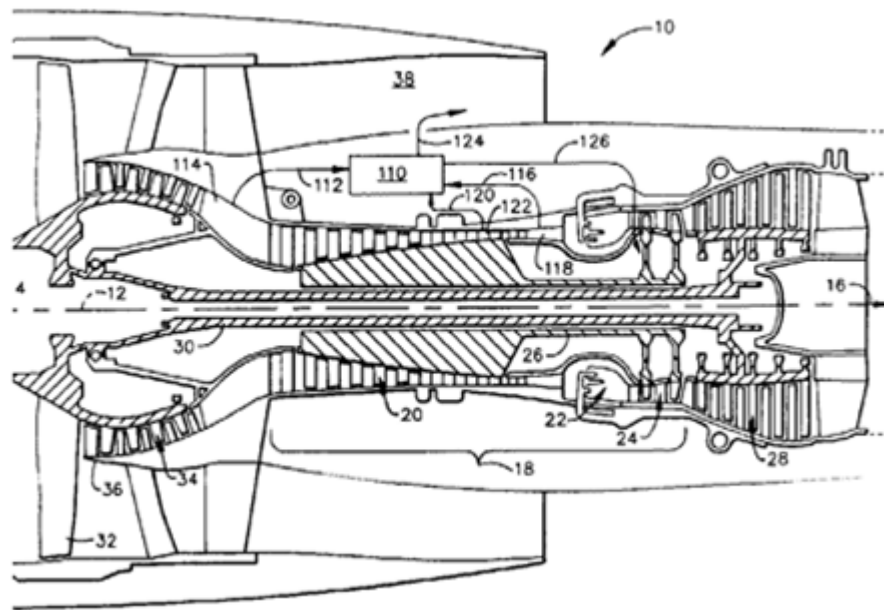

Figure 53: Turbine Cooling System improvement [124]

For interval analysis, the thermal efficiencies (E_t) of vanes and blades of first stage of the turbine is assigned the normalized interval [0.85, 1.15] whereas for deterministic analysis normalized value of E_t was set to 1. For application of Dempster-Shafer theory of evidence, the belief structure on E_t was assigned in the similar format shown in Figure 41 and Figure 42. The resulting complementary cumulative functions

for belief and plausibility (CCBF, CCPF) are shown in Figure 54 and Figure 55. It also shows the deterministic results and interval estimation outputs.

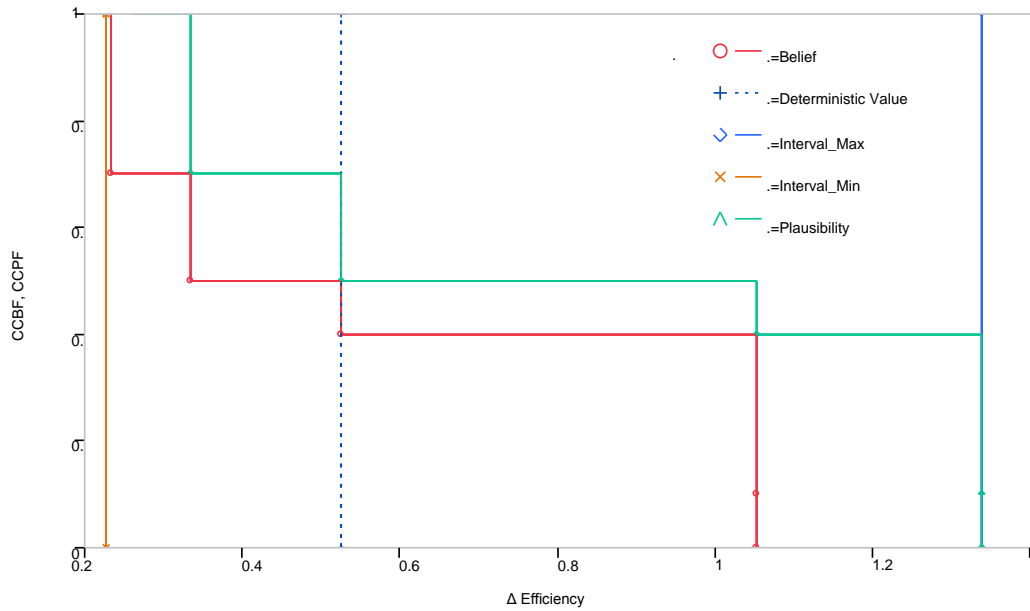

Figure 54. Uncertainty Propagation in Technology Valuation for TECH16: Plots of CCBF and CCPF [Bel($\tilde{x}>x$) or Pl($\tilde{x}>x$)] for Efficiency

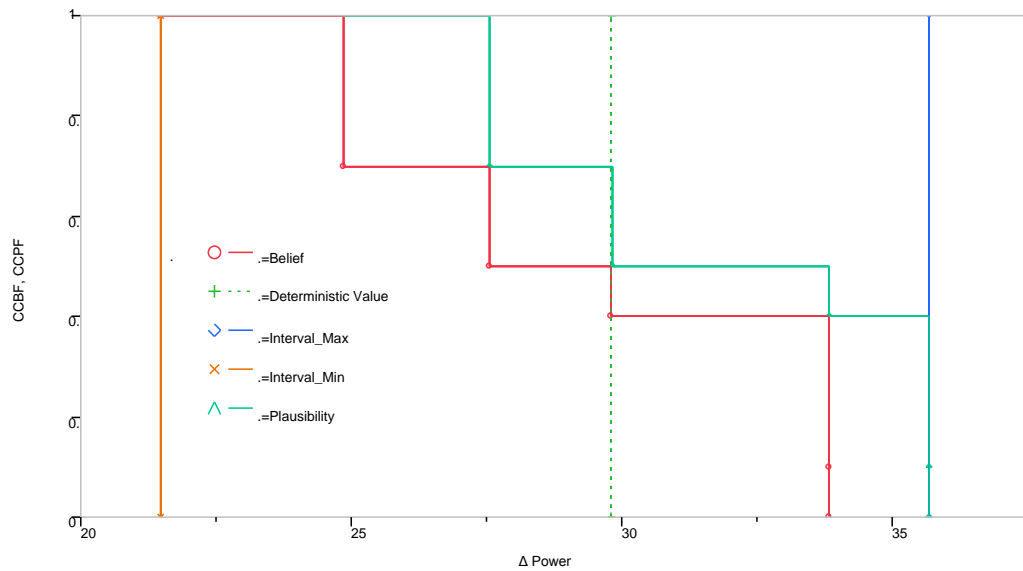

Figure 55. Uncertainty Propagation in Technology Valuation for TECH16: Plots of CCBF and CCPF [Bel ($\tilde{x}>x$) or Pl($\tilde{x}>x$)] for Power

TECH23: Material Systems Technology

This technology improves the Heat conductivity (H_c) of blades and vanes of turbine. Protective coating for provision of thermal barrier plays a major role in corrosion resistance. Use of advanced alloys further improves resistance to high temperatures.



Figure 56: Material Systems Technology [125]

The structure of only one stage will be shown here. For interval analysis, H_c is assigned the normalized interval $[0.85, 1.15]$ whereas for deterministic analysis normalized value of H_c was set at 1. For application of Dempster-Shafer theory of evidence, the belief structure on H_c was assigned in the similar format shown in Figure 41 and Figure 42. Cumulative belief and plausibility functions (CBF, CPF) are shown in Figure 57 for efficiency. It can be noted that $\text{Bel}(\tilde{x} \leq 0.27)$ is 0.3 and $\text{Pl}(\tilde{x} \leq 0.27)$ is 0.5.

The Complementary cumulative functions for belief and plausibility are shown in Figure 58 and Figure 59. It also shows the deterministic results and interval estimation

outputs. Complementary cumulative belief function and complementary cumulative plausibility function are an alternate presentation of CBF and CPF. They are denoted by $\text{Bel}(\tilde{x} > x)$ or $\text{Pl}(\tilde{x} > x)$.

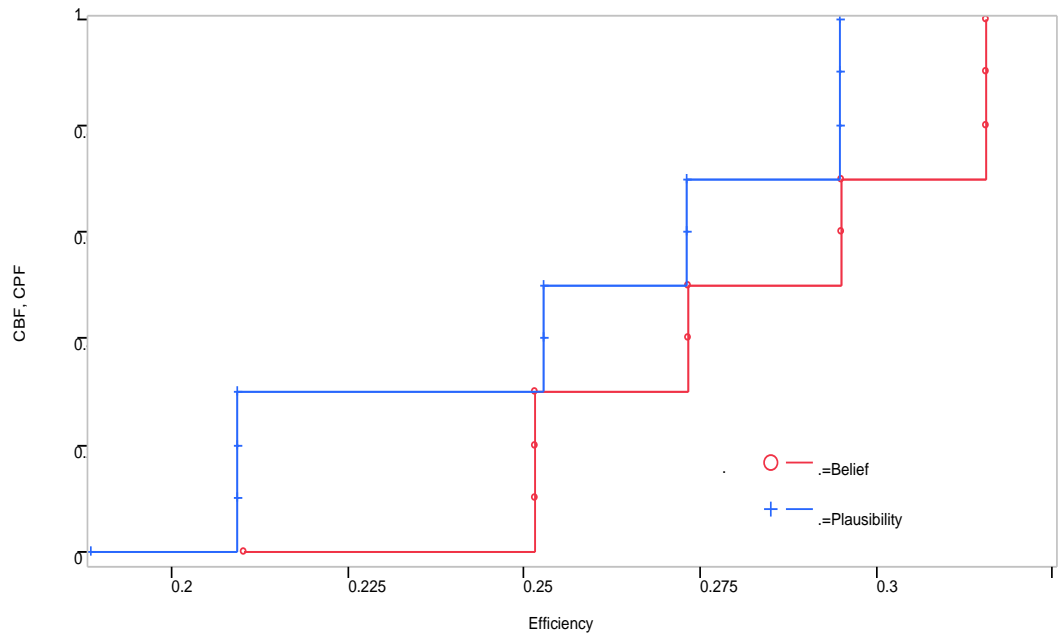

Figure 57. Uncertainty Propagation in Technology Valuation for TECH23: Plots of CBF and CPF [$\text{Bel}(\tilde{x} \leq x)$, $\text{Pl}(\tilde{x} \leq x)$] for Efficiency

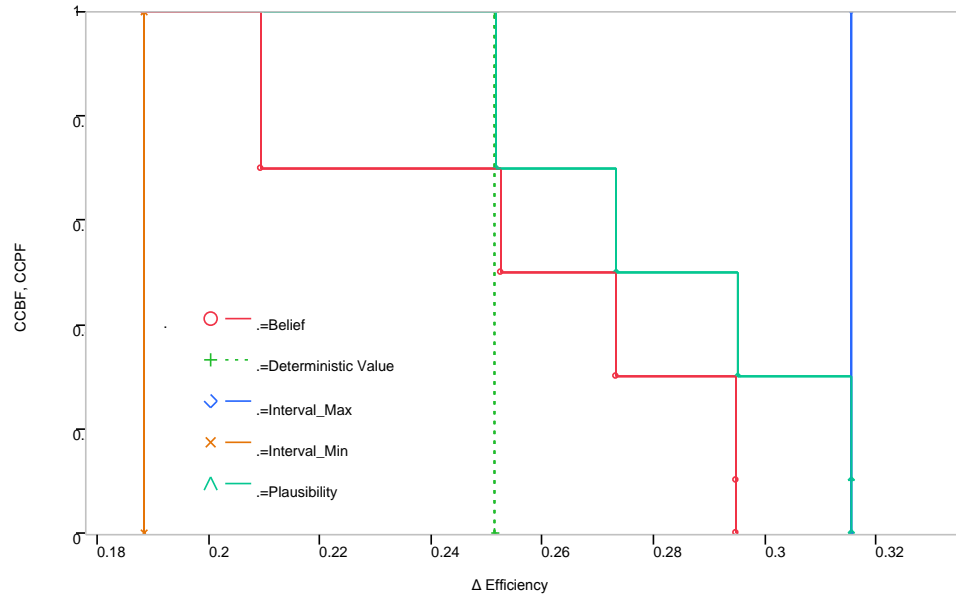

Figure 58. Uncertainty Propagation in Technology Valuation for TECH23: Plots of CCBF and CCPF [Bel ($\tilde{x}>x$) or Pl($\tilde{x}>x$)] for efficiency

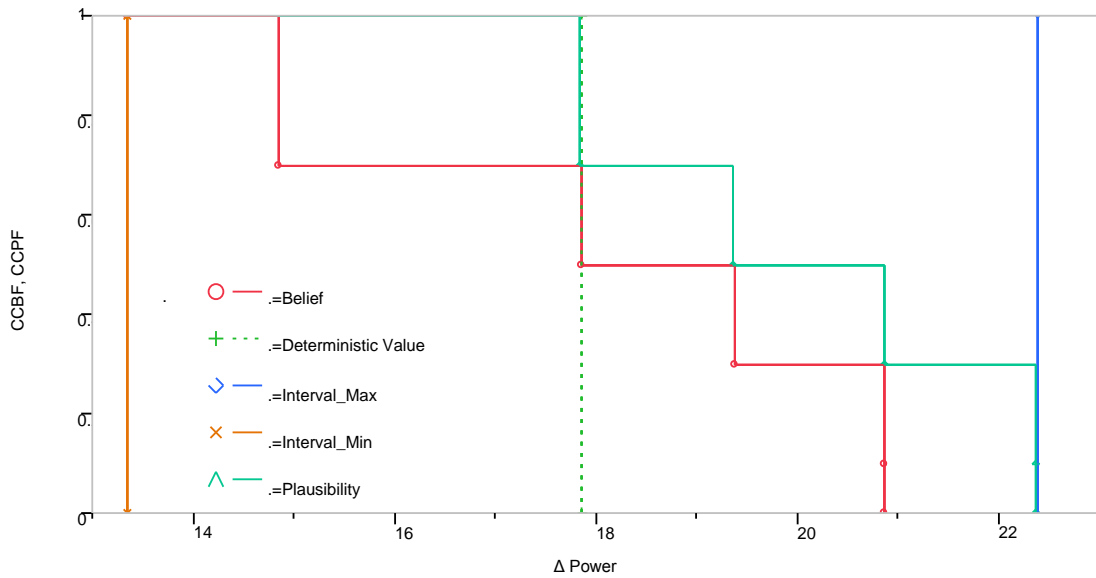

Figure 59. Uncertainty Propagation in Technology Valuation for TECH23: Plots of CCBF and CCPF [Bel ($\tilde{x}>x$) or Pl($\tilde{x}>x$)] for Power

TECH34: Advanced Turbine Airfoils

This technology uses advanced metals and innovative airfoil design to improve the efficiency of the gas turbines. Improvements in the cooling distributions in the core of the blade airfoil help reduce the temperature of the blades. The location and size of indentations on the blade surface facilitates the circulation of cooling flows.

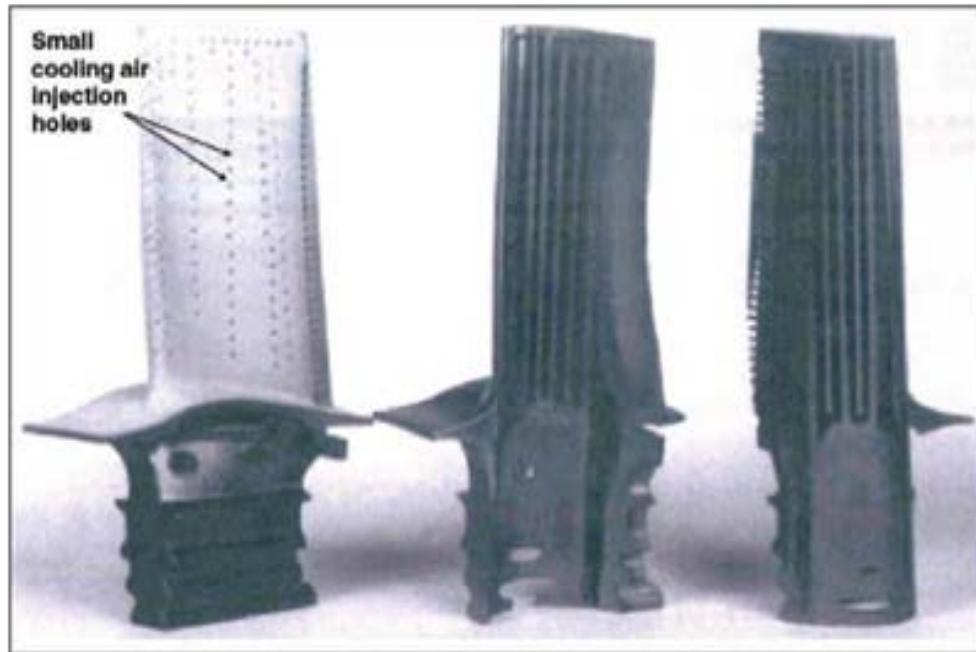

Figure 60: Advanced Turbine Airfoils [126]

It would improve the surface temperature (T_s) of the blades and vanes of the turbine. Although the impacts of all the stages are assessed, the inputs to only one stage are listed here. For interval analysis, the surface temperature (T_s) of the blades and vanes of first stage is assigned the normalized interval [0.85, 1.15] whereas for deterministic analysis normalized value of T_s was 1. For application of Dempster-Shafer theory of evidence, the belief structure on T_s was assigned in the similar format shown in Figure 41 and Figure 42. The resulting complementary cumulative functions for belief and plausibility are shown in Figure 61 and Figure 62. It also shows the deterministic results and interval estimation outputs.

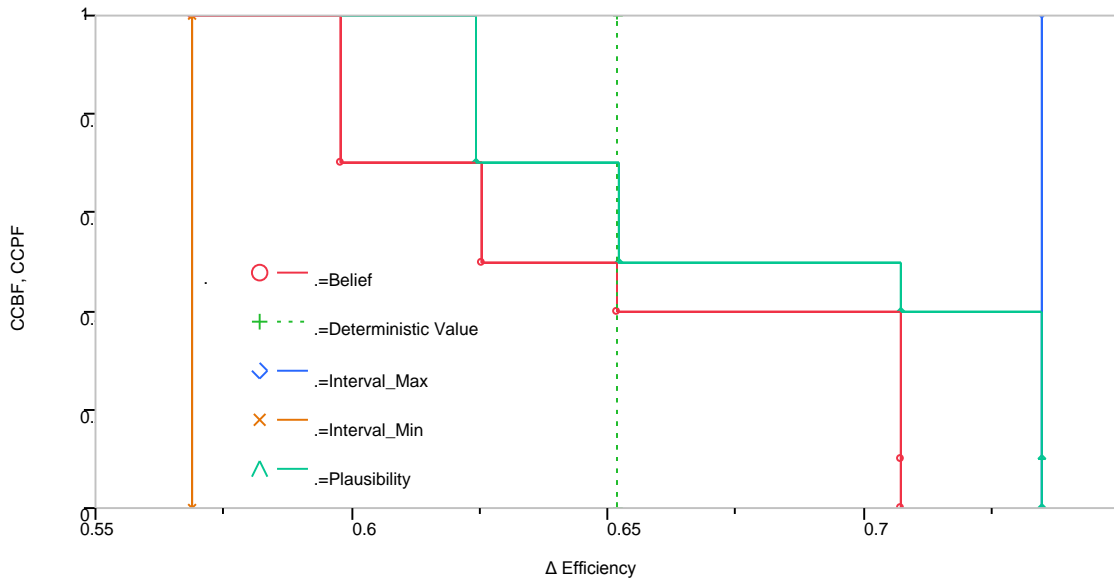

Figure 61. Uncertainty Propagation in Technology Valuation for TECH34: Plots of CCBF and CCPF [Bel($\tilde{x}>x$) or Pl($\tilde{x}>x$)] for Efficiency

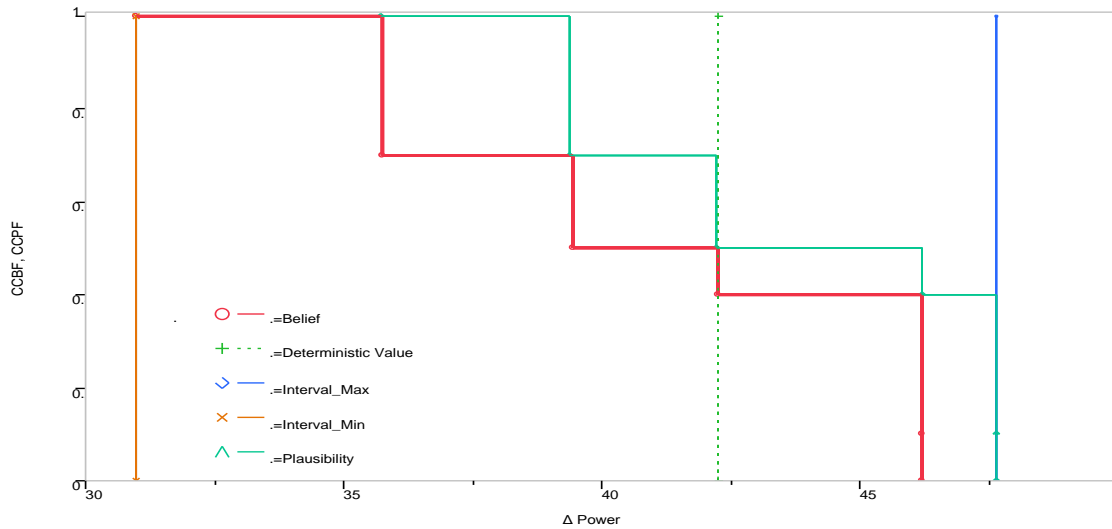

Figure 62. Uncertainty Propagation in Technology Valuation for TECH34: Plots of CCBF and CCPF [Bel($\tilde{x}>x$) or Pl($\tilde{x}>x$)] for Power

Portfolio 1: TECH07 and TECH16

When technologies are applied simultaneously, the portfolio of technologies is assessed and uncertainty on overall impact of all included technologies is assessed. In this study two portfolios are considered. Portfolio 1 consists of two technologies:

- (a) Compressor performance improvement
- (b) Turbine cooling system improvement

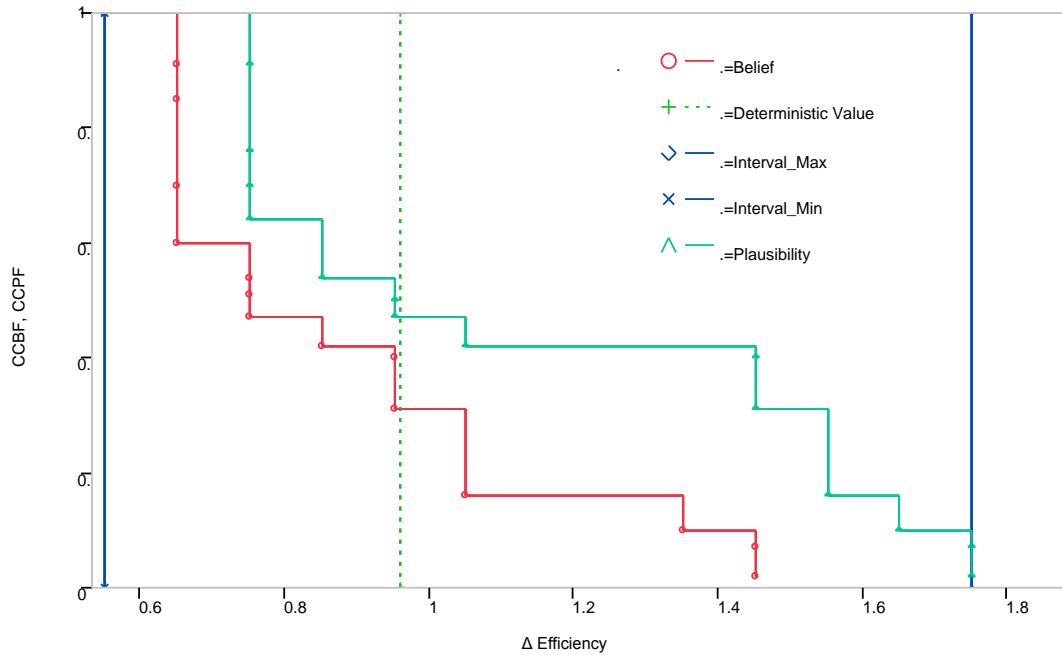

Figure 63. Uncertainty Propagation in Technology Valuation for Portfolio 1 (TECH07+TECH16): Plots of CCBF and CCPF [Bel($\tilde{x}>x$) or Pl($\tilde{x}>x$)] for efficiency

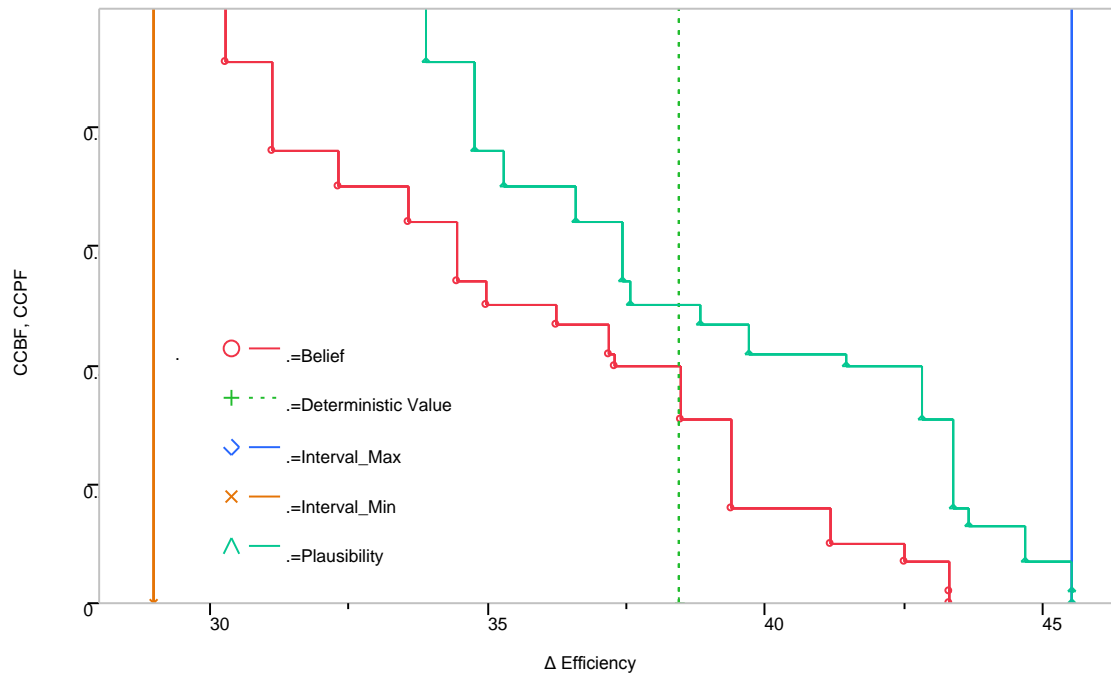

Figure 64. Uncertainty Propagation in Technology Valuation for Portfolio 1: Plots of CCBF and CCPF [Bel ($\tilde{x}>x$) or Pl($\tilde{x}>x$)] for Power

Portfolio 2: TECH01, TECH07, TECH16, TECH23, TECH34

After assessment of Portfolio 1, another portfolio is selected with five technologies and uncertainty analysis is performed. Portfolio 2 consists of following technologies:

- (a) Advanced Burner Concept
- (b) Compressor performance improvement
- (c) Turbine cooling system improvement
- (d) Material Systems Technology
- (e) Advanced Turbine Airfoils

Figure 65 and Figure 66 show cumulative belief function (CBF) and cumulative plausibility function (CPF). This is similar to cumulative distribution function (CDF) and CBF is the cumulative belief that uncertain variable \tilde{x} is less than a given value of x .

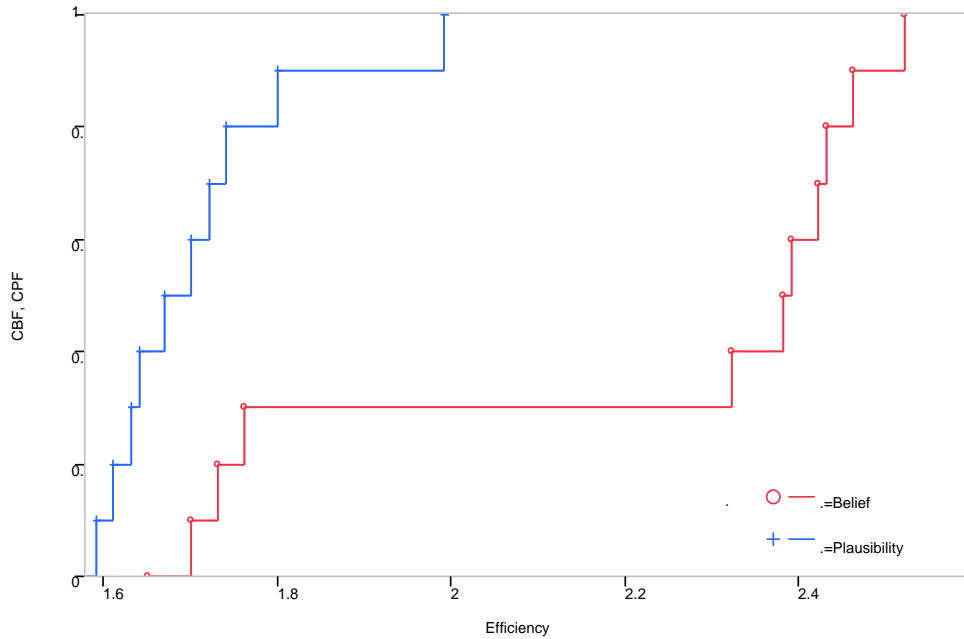

Figure 65. Uncertainty Propagation in Technology Valuation for Portfolio 2 (TECH01+TECH07+TECH16+TECH23+TECH34): Plots of CBF and CPF [Bel($\tilde{x} \leq x$), Pl($\tilde{x} \leq x$)] for Efficiency

Similarly CPF represent the cumulative plausibility that uncertain variable \tilde{x} is less than a given value of x . CBF and CPF are denoted as Bel($\tilde{x} \leq x$) and Pl($\tilde{x} \leq x$), respectively. In Figure 65, it can be seen that cumulative belief that efficiency improvement is less than or equal to 1.9% is 0.3 and cumulative plausibility that efficiency improvement is less than or equal to 1.9% is 0.9. Similar deductions can be assumed from Figure 66.

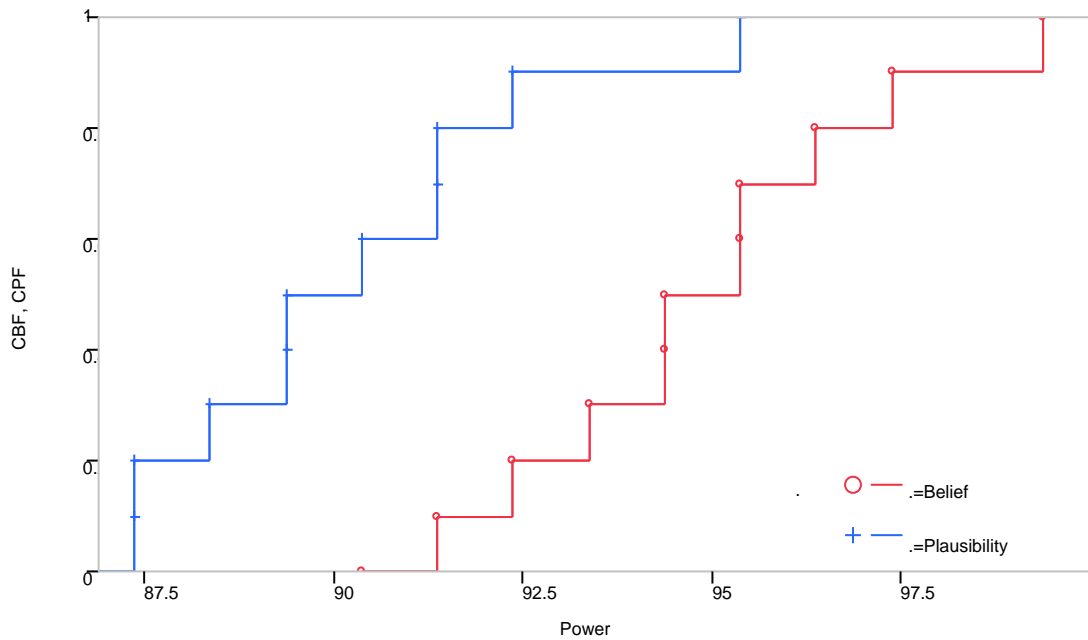

Figure 66. Uncertainty Propagation in Technology Valuation for PF2: Plots of CBF and CPF [Bel ($\tilde{x} \leq x$), Pl($\tilde{x} \leq x$)] for Power

Figure 67 and Figure 68 represent the complementary cumulative belief function (CCBF) and complementary cumulative plausibility function (CCPF) for efficiency and power, respectively. In this case there were high numbers of intervals thus large number of output intervals was created. This resulted in the CCBF and CCPF curves with fine steps.

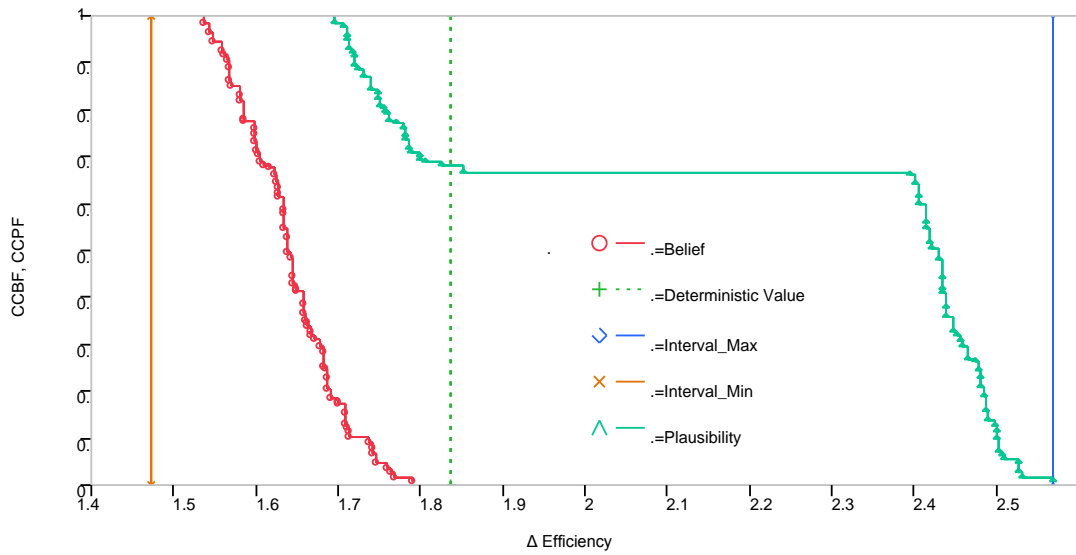

Figure 67. Uncertainty Propagation in Technology Valuation for PF 2: Plots of CCBF and CCPF [Bel ($\tilde{x}>x$) or Pl($\tilde{x}>x$)] for Efficiency

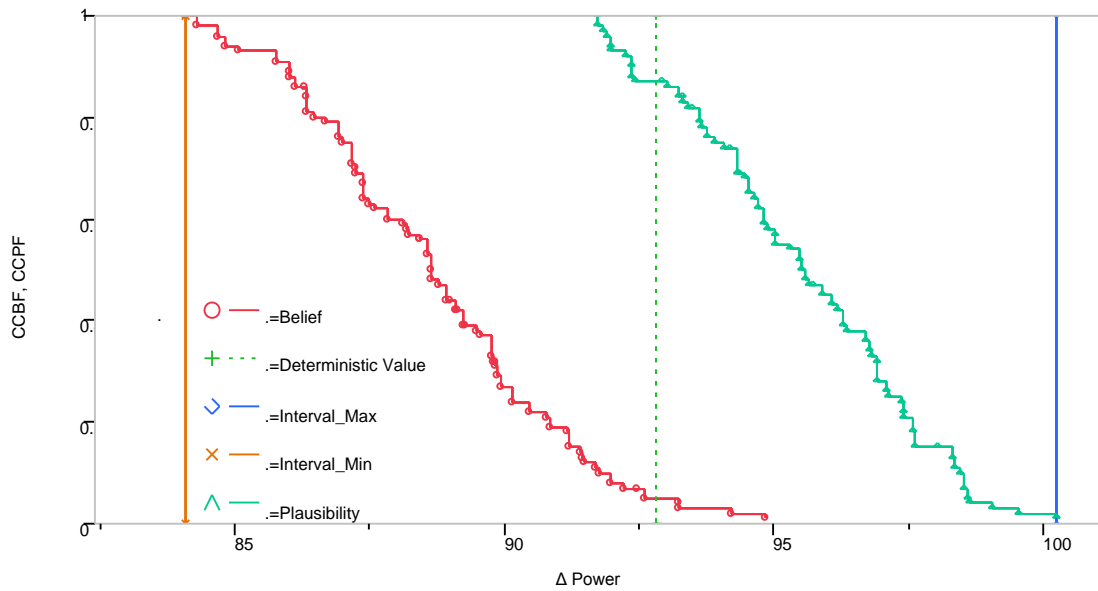

Figure 68. Uncertainty Propagation in Technology Valuation for PF2: Plots of CCBF and CCPF [Bel ($\tilde{x}>x$) or Pl($\tilde{x}>x$)] for Power

A comparison is also made to assess the impact of different configurations of intervals within the same extreme minimum and maximum values. It is shown Figure 69 and Figure 70. It can be observed that CCBF2 and CCPF2 have coarser intervals and thus producing bigger step sizes.

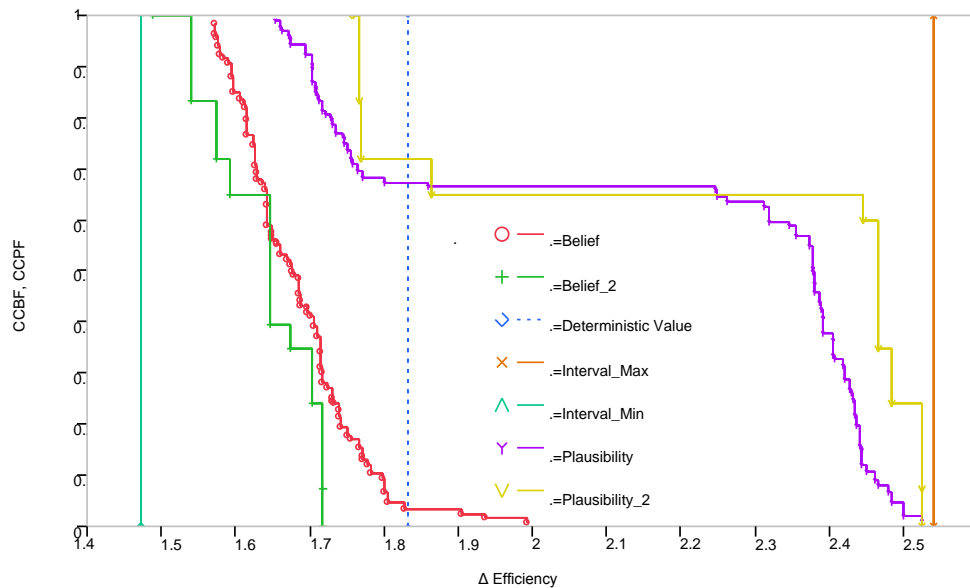

Figure 69. Uncertainty Propagation in Technology Valuation for PF2: Plots of CCBF and CCPF [Bel($\tilde{x}>x$) or Pl($\tilde{x}>x$)] for Efficiency: Comparison between different interval settings

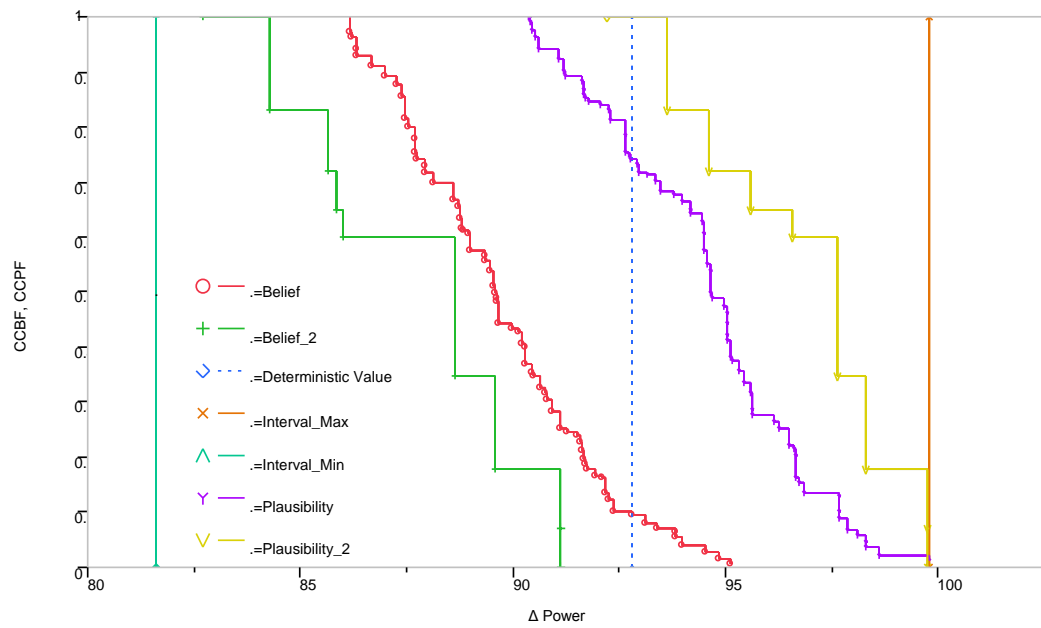

Figure 70. Uncertainty Propagation in Technology Valuation for PF2: Plots of CCBF and CCPF [$\text{Bel}(\tilde{x}>x)$ or $\text{Pl}(\tilde{x}>x)$] for Power: Comparison between different interval settings

Decision Making under Uncertainty

Margin analysis provides better understanding of the results that are obtained from quantification of epistemic uncertainty. It helps quantify the difference between the required level of performance and the estimated level of performance. If the required level of performance is achieved, it is represented by positive margin. In case the requirement is not met, the margin has a negative value. As shown previously, interval analysis based on Latin Hypercube sampling (LHS) of portfolio 2 yielded the interval for power improvement as [83.483, 98.953] as shown in Figure 71. Assume that there are two requirements for power improvements namely R1 and R2. Margin analysis of following two requirements will be discussed here:

R1: Power improvement should not be more than 100.37 MW.

R2: Power improvement should not be more than 98.37 MW.

For first case we have $R=100.37$ MW. It has also discussed previously that:

$$M(R, P|e) = R - P$$

Where M represents the margin, e is the vector of epistemic uncertain parameters. In case $M \geq 0$, it means that requirement is met, whereas $M < 0$ shows that requirement is not met.

So in first case: $M = [16.881, 1.422]$. As $M \geq 0$, so requirement is met.

In second case $M = [14.881, -0.578]$ and margin is not fulfilled in this case as a negative value is included in the margin M.

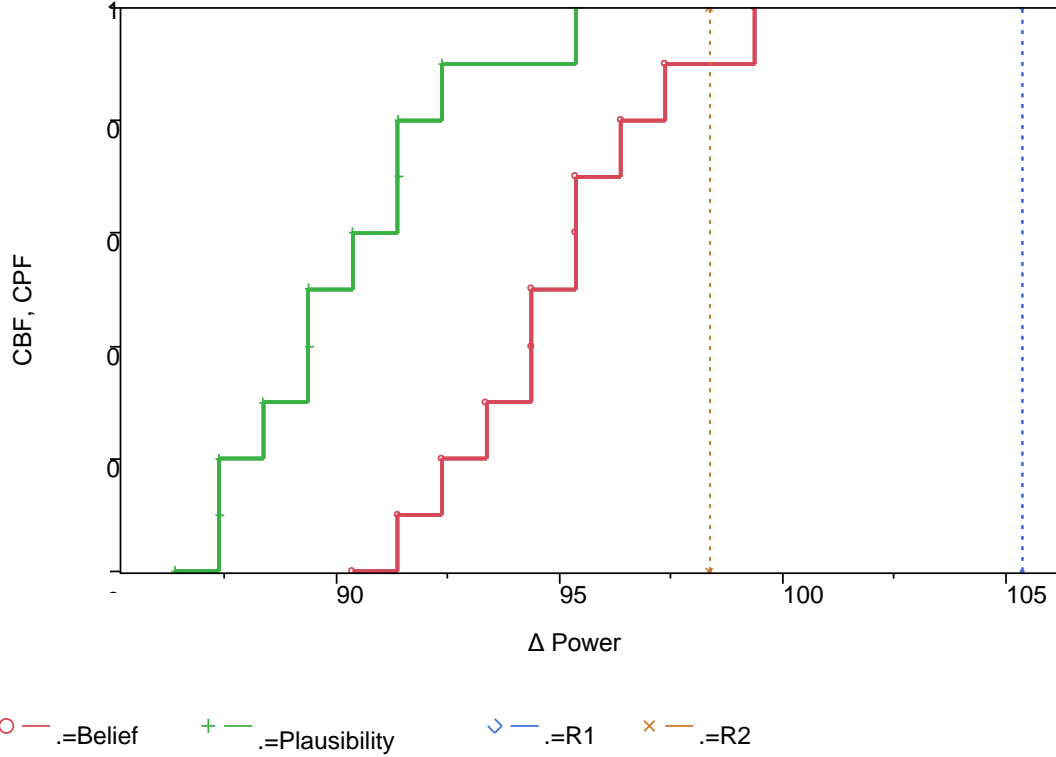

Figure 71. Uncertainty Associated with margin for Power Improvement

In case of results for portfolio 2 from Dempster-Shafer theory of evidence (Figure 71), the requirement number 1 yields value of both CBF and CPF as 1.

$$P_{100.37} = \{\tilde{P}: \tilde{P} \in P, \tilde{P} \leq 100.37\}$$

Hence $P_{100.37}$ can be represented as:

$$[Bel_P(P_{100.37}), Pl_P(P_{100.37})] = [1.0, 1.0]$$

But in case of requirement 2:

$$P_{98.37} = \{\tilde{P}: \tilde{P} \in P, \tilde{P} \leq 98.37\}$$

$P_{98.37}$ can be represented as:

$$[Bel_P(P_{98.37}), Pl_P(P_{98.37})] = [0.9, 1.0]$$

$$Bel_p(P_{98.37}^c) = 0.1$$

This implies that there is evidence supporting the fact that power requirement can be greater than 98.37 MW, which could not be fulfilled with present set of technologies.

As discussed in this example of margin analysis, it can be a powerful tool for decision makers. It presents an intuitive way to look at the difference between the required and estimated levels of performance in the context of epistemic uncertainties. Apart from margin analysis presented earlier, these results can be utilized to perform other analyses. Some of other analyses are listed below:

- (a) Epistemic uncertainty with specified bound
- (b) Epistemic uncertainty with specified bounding interval
- (c) Epistemic uncertainty with uncertain bound

These analyses can be performed according to the available information, type of input variables and objective of the study.

Now to further analyze these results different cases for quantification of margin and uncertainty (QMU) will be discussed. First a case uncertainty with specified bound on power improvement is considered. In such cases the requirement is plotted against the cumulative belief and plausibility functions and measured against expected performance parameters. Bounds on either side that is lower and upper perspective can be assessed. In Figure 72 it can be seen that all values of power improvement are above the lower bound (R)b1. The plausibility of power improvement falling below (R)b2 is 0.8 and associated value of belief is 0.1.

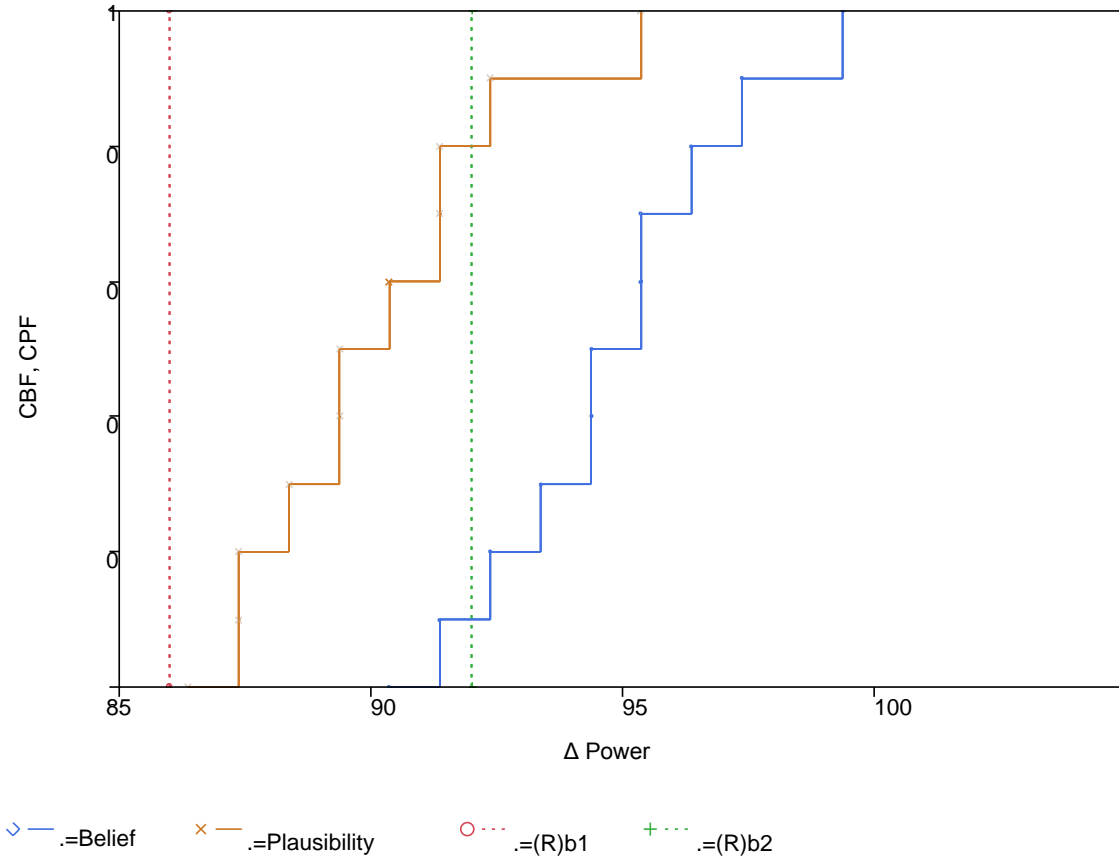

Figure 72. Uncertainty with Specified Bounds on Power Improvement

Similarly the analysis can be performed for the values of margin located beyond the upper value of complimentary cumulative belief and plausibility functions. It can be observed from Figure 73 that all values of for power improvement are below the bound (R)b4. In case of (R)b3 the plausibility of power improvement falling below is 0.3 and belief that value of power improvement can fall below (R)b3 is 0.

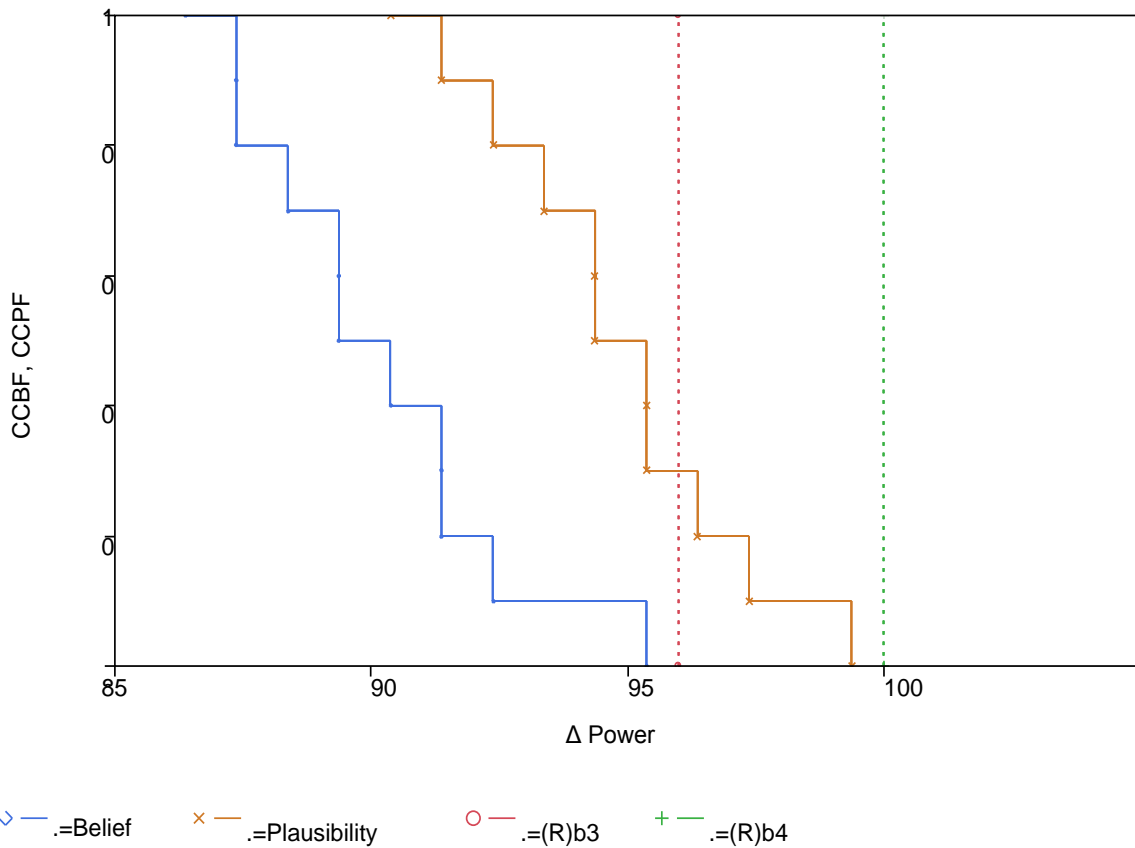

Figure 73. Uncertainty with Specified Bounds on Power Improvement

In terms of margin $M(R, P|e)$, bounds (R)bk with $k=1,2,3,4$ as shown in Figure 72 and Figure 73, can be generalized as following:

$$M(R, P|e) = \begin{cases} (R)bk - P, & \text{for } k = 1,2 \\ P - (R)bk, & \text{for } k = 3,4 \end{cases}$$

$M(R, P|e) > 0$ will indicate that specific requirement is met, whereas $M(R, P|e) < 0$ will indicate that requirement is not met.

In certain cases it becomes necessary to analyze bounding intervals for quantification of margin and uncertainty. The probability of performance with a specific

bounding interval is calculated. Margins for both lower and upper bounds, represented by (R)lb and (R)ub, are analyzed for estimated performance parameters. In this case value of (R)lb is assumed to be 88 MW and that of (R)ub is taken as 98 MW. Belief and plausibility for lower bound are shown as $Bel(X^+)$ and $Pl(X^+)$, whereas for upper bound they are shown as $Bel(X^-)$ and $Pl(X^-)$. From Figure 74, it can be seen that specified bounding interval results in following uncertainty for power improvement:

$$Bel_p(X^+) = 0.8 \quad Pl_p(X^+) = 1.0$$

and

$$Bel_p(X^-) = 1.0 \quad Pl_p(X^-) = 0.1$$

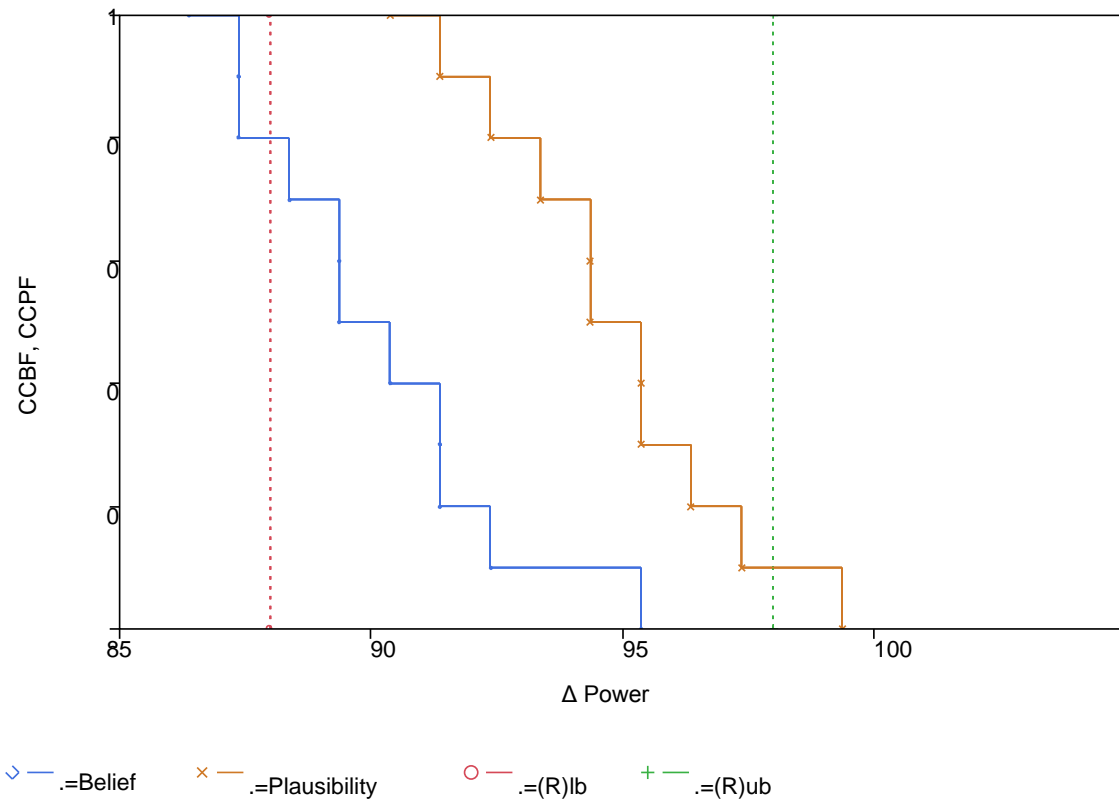

Figure 74. Uncertainty with Specified Bounding Interval on Power Improvement

The above representations explain the uncertainty in whether the specified margins will be met or otherwise when evidence theory based approach is utilized. In case of interval analysis, if the performance bounds are contained within the specified bounding interval the requirements are met. In a corresponding interval analysis of power improvement as shown in Figure 74, the uncertainty interval was [86.37 99.37]. This implies that the margins are not met, when the bounding interval is [88 98].

Another possibility of uncertainty is regarding the bounds themselves. In some cases the location of bounds are not clearly defined. The bounds can have different locations based on the various conditions such as operational environment and operating conditions. Now if the conditions are not exactly known for a specific requirement, it suggests that there is an uncertainty in the location of bound itself. In this case each bound can be treated as an uncertain bounding interval and analysis can be performed accordingly.

Quantification of margin and uncertainty (QMU) involves three aspects namely quantification, margins and uncertainty. Margins (M) in QMU involve the calculations of difference between requirements (R) and performance (P) of a system. In case of a single value it is simply represented by $M(R,P)$ such that:

$$M(R,P) = R-P, \text{ if } P \leq R$$

$$M(R,P) = P-R, \text{ if } P \geq R$$

If $M(R,P)$ is equal to or more than zero, the requirement is met but if $M(R,P)$ is less than zero, the requirement is not met. In many cases the requirement and performance correspond to a set of values and treated as vectors. Both requirement (**R**)

and expected performance (**P**) are represented by vectors and margin is calculated by comparing their corresponding elements. This analysis may be more complex than a situation with single number subtraction only. They can have the following structure:

$$\mathbf{R}=[R_1, R_2, R_3, \dots, R_n]$$

and

$$\mathbf{P}=[P_1, P_2, P_3, \dots, P_n]$$

Then M is denoted by a function $M(\mathbf{R}, \mathbf{P})$. Now if $M(\mathbf{R}, \mathbf{P}) \geq 0$, the requirements are assumed to be met, but in case of $M(\mathbf{R}, \mathbf{P}) < 0$, the requirements are not met. Similarly it is also possible to have $\mathbf{M}(\mathbf{R}, \mathbf{P})$ as a vector itself and can be represented as following:

$$\mathbf{M}(\mathbf{R}, \mathbf{P})=[M_1(R_1, P_1), M_2(R_2, P_2), \dots, M_i(R_i, P_i), \dots, M_n(R_n, P_n)]$$

To decide on the requirement conditions the minimum or weighted average of the components i.e. $M_i(R_i, P_i)$ is taken. These representations of the margin do not assume any uncertainty in margin, but if the uncertainty is present in the margins, an additional component of uncertainty \mathbf{e}_M is included in the analysis. Margin is then denoted by $M(\mathbf{R}, \mathbf{P} | \mathbf{e}_M)$, where $\mathbf{e}_M=[e_{M1}, e_{M2}, e_{M3}, \dots, e_{Mn}]$. The values of \mathbf{e}_M are often not known precisely and associated epistemic uncertainty can be characterized through Dempster-Shafer theory of evidence.

The quantification of these margins requires a deep understanding of mathematical components as well as the actual performance uncertainties. If P and R represent performance and requirement respectively, e_R and e_P represent epistemic uncertainties associated with P and R. In case a requirement does not have any

uncertainty associated with it, it can be simply shown by a vector “**R**”, otherwise it is represented by a vector function **R**(**e_R**). Similarly a function **P**(**e_P**) represents a vector function for epistemic uncertainty associated with performance of the system. These functions define margin as following:

$$M(\mathbf{R}, \mathbf{P}|\mathbf{e})=M[\mathbf{R}(\mathbf{e}_R), \mathbf{P}(\mathbf{e}_P)]$$

Calculations of functions **R**(**e_R**) and **P**(**e_P**) are sometimes very complex and computationally expensive.

The presentation of QMU needs to be planned in such a way that it conveys the intended results. Cumulative or counter-cumulative belief and plausibility functions with vertical line acting as margin or requirement on performance index of the system represent a good depiction of the problem. For lower and upper bounds different setup is needed to extract the useful information. It is also emphasized that efforts to reduce the uncertainty results to a single number need to be carefully evaluated. Lot of useful information is lost while trying to over-simplify the uncertainty analysis.

Discussions on Technology Insertion Based on Technology Readiness Level

Many factors influence technology investment decisions. One of the important factors is the technology readiness levels (TRL) [127] of respective technologies. Based on available time for program launch, certain technologies can be included or excluded from the portfolio prioritization process. TRL and associated projected funding for technologies can be used to prioritize the technology portfolios in various scenarios. Figure 75 shows a representative timeline for selection of technologies. The vertical dashed blue line in Figure 75 shows present time on a 16 year timeline horizontal axis. Horizontal bars show TRL's according to timescale. For example, Tech 1 can achieve TRL 9 in around four years from now, whereas Tech 4 would take another 8 years to be ready for program insertion. Although TRL 9 is considered to be the phase where technology has been tested in actual environment and finally ready for integration into the system, sometimes organizations are just interested in a lower TRL before declaring a technology readiness for its inclusion in a program for their budgetary decisions. This is dictated by the strategic approach and acceptable risk level of the organization. For example, some organizations consider TRL 6 to have acceptable risk level to be considered for program insertion.

The cost associated with each TRL can sometimes be enhanced to accelerate the technology development process. Although it is not always possible due to sequential nature of technology development, additional funding may be used to get to a desired TRL in shorter time. In Figure 75, Tech 5 is showing this behavior. Normal development of Tech 5 would take eight years to reach to TRL 9 whereas an accelerated schedule of Tech 5 would require six years to mature. Accelerated schedules incur a cost penalty associated with them.

The balance between cost and TRL can be utilized to generate and assess various scenarios. Some of the common scenarios are shown in Figure 75. A brief explanation of them is as following:

- (a) Scenario 1: Program launch at specified time with limited availability of funds.
- (b) Scenario 2(a): Program launch at a specified time with high level of available funding. Budget allows accelerated development of technology to accommodate it within compressed timeframe.

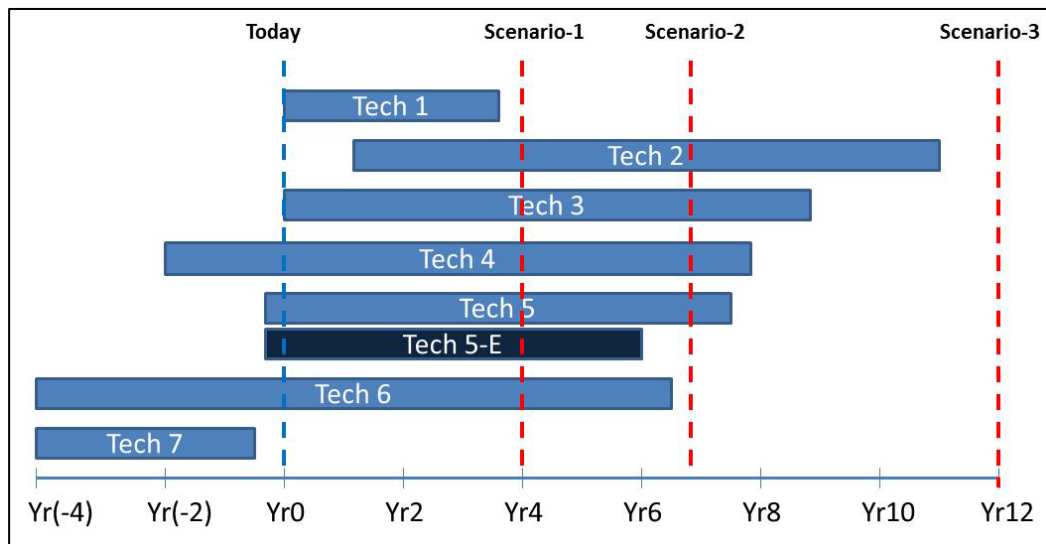

Figure 75. Technology insertion into program according to TRL timings

- (c) Scenario 2(b): Same as 2(a), but with a specified TRL (e.g. TRL=3). This sometime helps to demonstrate the conceptual performance achievements with existing portfolio.
- (d) Scenario 3(a): Program launch date is far enough, such that expected development of all the technologies is possible. Available funding is constrained.

(e) Scenario 3(b): Program launch date is far enough, such that expected development of all the technologies is possible. Target performance objectives are required to be achieved while minimizing the required funding.

CHAPTER 8

CONCLUSIONS

Technology valuation for future technologies is a complex problem that requires analysis of the concepts, which have not been tested yet. This also implies that in such cases the available data is not sufficient make future performance predictions. There are many uncertainties in this process.

Knowledge and experts

Knowledge elicitation is a foundation for the exploration of new ideas in technological advancements. Subject matter expert can provide a good insight on the impact of technologies on the systems. However the knowledge elicitation for subject matter expert remains a complicated process. If this process is not handled carefully, it can lead to misleading conclusions.

Expert elicitation requires collection of their opinion in the form which is useful to further the knowledge about the system in question. It is important to understand how these opinions are formed and how they should be treated. Opinions are processed manifestation of information and knowledge that can be assessed through the justifiable true belief (JTB) criteria and are not necessarily infallible. Opinions represent the propositional type of knowledge. These expert opinions may not meet all the conditions of JTB and reliability theory of knowledge; hence, they can be proven false or negated by other experts later on. Careful selection of experts can help minimize the error but the analyst should be able to identify and quantify the uncertainties in the process. Elicitation process needs to be transparent, well-structured and well-documented. It is observed that in case of lack of knowledge about the problem, epistemic uncertainty is most suitable representation of the process. It reduces the number of assumptions during the elicitation

process, when experts are forced to assign probability distributions to their opinions without sufficient knowledge. Epistemic uncertainty can be quantified by many techniques. In present research it is proposed that interval analysis and Dempster-Shafer theory of evidence are better suited for quantification of epistemic uncertainty in the technology valuation process.

Another challenge in expert elicitation is combining the evidence from different experts. In case of quantitative elicitation, generally the experts are asked to give their opinion on quantities, rather than any indirect utility functions or ranking. To combine these opinions, Dempster's rule of combination is suggested in this study. Suggested elicitation process requires that experts be given independence by just proposing the ranges for the elicited entities. They can offer more than one range for the same variable with pre-assigned basic probability assignments for each sub interval. These intervals can be adjacent, apart or overlapping. Within these ranges, no distribution is assigned to these quantities. They can assume any value within the range.

Uncertainty propagation

Epistemic uncertainties represent lack of knowledge. In order to quantify and propagate this type of uncertainty without requiring lot of assumptions, an appropriate theory needs to be selected. Some of these techniques include probability theory, the theory of fuzzy sets, Dempster-Shafer theory, possibility theory, interval analysis, second order probability and convex model of uncertainty. These techniques are discussed previously in this document. Some techniques can handle epistemic uncertainties only, whereas some can handle both aleatory and epistemic type of uncertainties. For current study Dempster-Shafer theory of evidence is utilized along with interval analysis for comparison of results.

Interval analysis

Interval analysis technique is used when there is no other information is available, except that input variables lie within a certain interval. There are two ways to implement interval analysis: Sampling based and Optimization based. If interval analysis is implemented on computationally expensive environment, it may require prohibitive time and resources, but if used in combination with surrogate modeling, it considerably reduces the computational effort. For sampling based analysis, Latin Hypercube sampling (LHS) was used. Optimization through efficient global optimization (EGO) technique was implemented. It was observed that both techniques provided accurate results which were very close to each other. EGO technique reached the solution with fewer function calls.

Dempster-Shafer Theory of Evidence

Dempster-Shafer theory of evidence is a non-intrusive method for quantification of epistemic uncertainty. When the available information is non-specific, ambiguous or conflicting, evidence theory relaxes the assumptions of probability theory. In case of multiple experts, the combination of the evidence is performed by different methods including Dempster rule and weighted mixing rule of combination. Dempster rule was later applied due to the compatible nature of the problem, type of inputs from elicitation and ease of implementation.

Dempster-Shafer theory of evidence is applied for uncertainty quantification for technology valuation of an aircraft engine. A second order response surface surrogate was created to map input variables to objective functions. Sensitivity study was carried out against all the outputs and their sensitivities to variability in the input efficiencies were quantified. The inputs which do not have any significant impact on the outputs were filtered out from simulations for the purpose of uncertainty propagation. This was

followed by study on impact of sample size on time required and accuracy of the solution. Sample size of 10^3 , 10^4 and 10^5 were evaluated. Sample size of 10^4 was used as it was able to predict the solution accurately. Cumulative belief and cumulative plausibility distributions were obtained after application of Dempster-Shafer theory of evidence. Comparisons were made with belief structures obtained from different rules of combination and probability theory.

Technology interactions

Technology valuation involves elicitation from experts about possible outcome of new technologies on the system. Various methods have been adopted to quantify and apply this impact on the system to assess the objective functions. Many of these methods use a technology impact matrix (TIM) to capture the independent, one-at-a-time, impacts of all the technologies on k-factors and performance metrics. Current methods do not account for nonlinear interactions between technologies. This may lead to erroneous results for some inherently nonlinear problems. This can also lead to situations which violates the physical constraints of the problem. To overcome this problem, a new set of technology synergy matrices (TSM) is introduced to capture the higher order interactions between technologies through subject matter expert opinion and historical data. This newly introduced Technology synergy matrices would record the technology interactions and better represents the physics of problem. A detailed description of TSMs and their usage in conjunction with technology impact matrices and technology compatibility matrices is discussed. Various combination methods are also proposed, which can be applied according to the type of interactions. A notional aircraft design problem is addressed with the newly proposed setup. This setup is successfully implemented on the example problem. Comparisons are also made between all proposed combination methods.

Large Scale Example Application

A test case for quantification of epistemic uncertainty on a large scale problem of combined cycle power generation system was applied. A detailed multidisciplinary modeling and simulation environment was adopted for this problem. High fidelity simulations were very expensive for this multidisciplinary setup, so a neural network based surrogate model was developed. This surrogate model significantly reduced the computational effort.

Expert elicitation was done for the five selected technologies from different areas. Expert elicitation was obtained for various analyses based on deterministic, interval estimation and Dempster-Shafer theory of evidence. All three types of approaches were implemented for comparison. Sampling based interval analysis was carried out on power generation problem. It is then compared with Optimization based interval analysis. Sampling based uncertainty estimation was easy to implement, but it took more time and function calls than optimization based analysis. Finally Dempster-Shafer theory of evidence was applied on the combined cycle power generation problem. It was implemented through surrogate model as well, because it can be very expensive if the modeling and simulation code uses excessive computational effort. All the five technologies and two portfolios were analyzed. The results were presented in the form of cumulative belief functions (CBF), cumulative plausibility functions (CPF), complementary cumulative belief functions (CCBF) and complementary cumulative plausibility functions (CCPF). These results are graphically compared with interval analyses and deterministic approach. This comparison clearly shows the amount of information that is available from each analysis. In interval estimation, only bounds of the objective function are known. In Dempster-Shafer theory of evidence, a stair like functions namely CBF and CPF provide more elaborate details. At the end margin analyses were performed to utilize these epistemic based uncertainty results. In margin

analysis different target values were evaluated against technology capabilities obtained from interval analyses and Dempster-Shafer theory of evidence.

Future Work

In this study the focus has been on the parameter uncertainty. Another aspect which can be combined with this study is to combine model uncertainty as well. This approach is important where multi-fidelity codes are applicable or where lack of information exists for simulation conditions. In such cases adding model form uncertainty better captures the overall uncertainty of the system.

Technology synergy matrices (TSM) approach captures the non-linear impact of technology interactions in a portfolio. It may be applied to previously analyzed technology valuation problems to improve upon the results.

In this research Dempster-Shafer theory of evidence and interval analysis approaches are applied successfully on a combined cycle power generation system. The uncertainty quantification is focused on epistemic uncertainty, which is different approach from the previous technology valuation efforts i.e. based on probability theory. Epistemic uncertainty can be assumed and implemented in technology valuation processes in other areas as well.

Manufacturing readiness levels (MRL) are used to identify manufacturing maturity of a technology and complements technology readiness levels. Figure 76 shows the relationship between manufacturing readiness levels with technology readiness levels. It helps mitigate manufacturing related risks. Incorporation of manufacturing readiness levels in technology development process ensures that the technology is ready to be manufactured as soon it passes its development phase. MRL can be introduced in the process for epistemic uncertainty perspective.

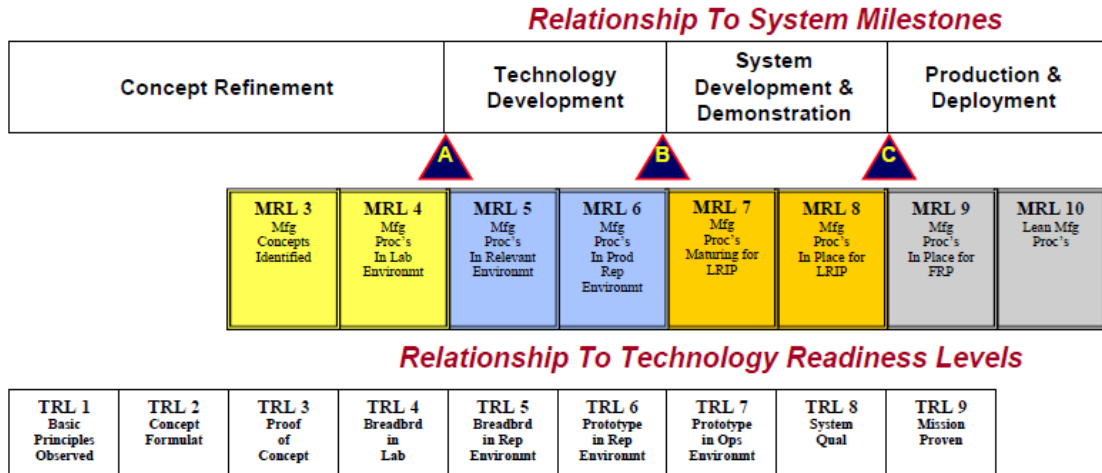

Figure 76: Manufacturing Readiness Levels and their Relationship to Technology Readiness Levels

(<http://www.dtic.mil>)

Summary of Contributions

This research offer following contributions upon its successful completion:

- (a) Based on literature search on process of acquisition of human knowledge, it is suggested that expert opinion is more likely to be subjected to epistemic uncertainty.
- (b) For combination of evidence, exploration and implementation of Dempster rule of combination and weighted rule of combination.
- (c) Application of interval analysis on quantitative technology valuation to capture epistemic uncertainty. Application and comparison of Latin hypercube sampling (LHS) and efficient global optimization (EGO) approaches.
- (d) Application of Dempster-Shafer theory of evidence to quantify and propagate epistemic uncertainties in technology valuation processes.
- (e) Implementation of margin analysis for technology valuation process.

- (f) Introduction of technology synergy matrices to better capture the nonlinear effects of technologies. This newly introduced layer in technology valuation process improves the technology impact estimation.
- (g) Use of real options in integrated environment for financial modeling within technology valuation process.

APPENDIX A

INTRODUCTION TO DAKOTA

DAKOTA (Design and Analysis toolkit for Optimization and Terascale Applications) is a project by Sandia National Laboratories. It encompasses a wide array of algorithms that support advanced methods for optimization, sensitivity analyses, parameter estimation and uncertainty quantification[118, 119]. It helps address many key questions arise from simulation-based engineering problems. In sensitivity analyses, the crucial parameters of the system are evaluated and their impacts on the key metrics are assessed. Uncertainty quantification addresses the issues regarding variability, reliability and robustness of the system with the help of quantification of margin and uncertainty (QMU). Optimization helps identify the best performing design or control and calibration supports regarding the models and parameters that best match the experimental data. To achieve these intended benefits for different needs and analyses, algorithms both from classical theories as well as advanced methods are incorporated. Optimization can be performed with gradient and nongradient based methods whereas uncertainty quantification can be done with sampling, interval, stochastic expansion, reliability, and epistemic nondeterministic methods. Sensitivity analysis can be applied with design of experiments (DOE) and parameter study methods. Parameter estimation is done with the help of nonlinear least squares methods. In most of the involved engineering applications these methods are used in conjunction with broader applications such as optimization under uncertainty, and mixed aleatory-epistemic uncertainty.

JAGUAR (Java GUI for Applied Research) is the graphical user interface (GUI) for creation, modification and execution of DAKOTA input files. Although DAKOTA can be executed on command line as well, but JAGUAR have many additional GUI based features. It can parse the DAKOTA input file and offers a complete set of problem setup and option specifications. It can read an existing input file, create a new file and have a

set of templates which can help the user to build a method specific input file. In the GUI, there are two sections for problem definition. First section defines the model and describes how variables are linked to the responses through interfaces. The next section defines the flow and iteration of the problem. In this section strategy and respective methods are defined. JAGUAR performs inputs validation as the values are fed in the GUI based forms. In case of conflicting inputs, the user is alerted to correct the problem interactively.

Two sections are dedicated to perform analysis and visualize results in JAGUAR. In execution related section, options for checking, and execution of code are provided. In execution part Core run, pre-run, and post-run options are available. JAGUAR can perform additional checking of the input file to determine any problems in the structure of the input file. After the checking the input file, the analysis is executed. All the scripts need to have valid paths to avoid any problem during the execution phase. Some methods such as parameter study and design of experiments require a pre-run component to generate required files or data for the main execution of the problem. The pre-run option is used in these cases to provide the complete sets of input to the code. Similar to pre-run requirement a post-run option is used when an output statistic is helpful in analysis of the results. They are particularly useful in sensitivity analysis. Results visualization display the results from the execution of the input file. JAGUAR also has the capability to monitor the job status for the DAKOTA jobs submitted to a remote cluster.

APPENDIX B

SAMPLE INPUT FILES FOR UNCERTAINTY QUANTIFICATION

Dempster Shafer Theory of Evidence

strategy

tabular_graphics_data

single_method

method_pointer = 'EV1'

method

id_method = 'EV1'

model_pointer = 'EV1'

nond_global_evidence lhs

samples = 10000

seed = 59334 rng rnum2

response_levels = 1.5 1.7 1.9 2.1 2.3 2.5 85 88 91 94 97 100

probability_levels = 0.1 0.25 0.5 0.75 0.9 1.0 0.1 0.25 0.5 0.75 0.9

1.0

distribution cumulative

output verbose

variables

```
id_variables = 'variablesForEV1'  
# PortFolio_2: (T1,T2,T3,T4,T5)  
interval_uncertain = 5  
    num_intervals = 3 3 2 2 2  
    interval_probs = 0.3 0.4 0.3 0.4 0.3 0.4 0.4 0.6 0.6 0.4 0.7 0.3  
    interval_bounds = 0.85 0.95 0.95 1.05 1.05 1.15 0.85 0.95 0.95 1.05  
    1.05 1.15 0.85 0.95 0.95 1.15 0.85 1.0 1.0 1.15 0.85 1.05 1.05 1.15  
    descriptors = 'T1' 'T2' 'T3' 'T4' 'T5'  
continuous_state = 30  
    initial_state = 0 0 0 0 0 0 0 0 0 0 0 0 0 0 0 0 0 0 0 0 0 0 0 0 0 0 0 0  
    0  
    descriptors = 'T6' 'T7' 'T8' 'T9' 'T10' 'T11' 'T12' 'T13' 'T14' 'T15'  
    'T16' 'T17' 'T18' 'T19' 'T20' 'T21' 'T22' 'T23' 'T24' 'T25' 'T26' 'T27'  
    'T28' 'T29' 'T30' 'T31' 'T32' 'T33' 'T34' 'T35'
```

interface

```
analysis_drivers = '/share/TechValuation/EV1.bash'  
system  
    parameters_file = 'pr'  
    results_file = 'rs'  
    file_tag  
    file_save  
asynchronous  
    evaluation_concurrency = 100
```

responses

id_responses = 'forEV1'

descriptors = 'Elect_Eff' 'Elect_Power'

num_response_functions = 2

no_gradients

no_hessians

model

id_model = 'EV1'

variables_pointer = 'variablesForEV1'

responses_pointer = 'forEV1'

single

Interval Analysis

```
strategy
  tabular_graphics_data
  single_method
  method_pointer = 'INT1'

method
  id_method = 'INT1'
  model_pointer = 'INT1'
  nond_global_interval_est lhs
  samples = 10000

variables
  id_variables = 'variablesForINT1'
  # PortFolio_2: (T1,T2,T3,T4,T5)

interval_uncertain = 5
  num_intervals = 1 1 1 1 1
  interval_probs = 1.0 1.0 1.0 1.0 1.0
  interval_bounds = 0.85 1.15 0.85 1.15 0.85 1.15 0.85 1.15 0.85 1.15
  descriptors = 'T1' 'T2' 'T3' 'T4' 'T5'
```

```
continuous_state = 30  
initial_state = 0 0 0 0 0 0 0 0 0 0 0 0 0 0 0 0 0 0 0 0 0 0 0 0 0 0 0 0 0 0 0 0 0 0  
descriptors = 'T6' 'T7' 'T8' 'T9' 'T10' 'T11' 'T12' 'T13' 'T14' 'T15' 'T16' 'T17'  
'T18' 'T19' 'T20' 'T21' 'T22' 'T23' 'T24' 'T25' 'T26' 'T27' 'T28' 'T29' 'T30'  
'T31' 'T32' 'T33' 'T34' 'T35'
```

interface

```
analysis_drivers = '/share/TechValuation/INT1.bash'
```

system

```
parameters_file = 'pr'
```

```
results_file = 'rs'
```

```
file_tag
```

```
file_save
```

asynchronous

```
evaluation_concurrency = 100
```

responses

```
id_responses = 'forINT1'
```

```
descriptors = 'Elect_Eff' 'Elect_Power'
```

```
num_response_functions = 2
```

```
no_gradients
```

```
no_hessians
```

model

id_model = 'INT1'

variables_pointer = 'variablesForINT1'

responses_pointer = 'for INT1'

single

APPENDIX C:

OUTPUT RESULTS FILES

This Appendix has selected extracts from the results of the following simulations:

- (a) Technology Portfolio 2: Dempster-Shafer Theory of Evidence
- (b) Technology Portfolio 2: Interval Analysis
- (c) Technology Portfolio 1: Dempster-Shafer Theory of Evidence
- (d) Technology Portfolio 1: Interval Analysis
- (e) Tech01: Dempster-Shafer Theory of Evidence
- (f) Tech01: Interval Analysis
- (g) Tech07: Dempster-Shafer Theory of Evidence
- (h) Tech07: Interval Analysis
- (i) Tech16: Dempster-Shafer Theory of Evidence
- (j) Tech16: Interval Analysis
- (k) Tech23: Dempster-Shafer Theory of Evidence
- (l) Tech23: Interval Analysis

Technology Portfolio 2: Dempster-Shafer Theory of Evidence

```
Technology Portfolio 2 (Tech1 + Tech7+ Tech16+ Tech23+ Tech34)
Writing new restart file dakota.rst
methodName = nond_global_evidence
gradientType = none
hessianType = none
>>>>> Running nond_global_evidence iterator.
>>>>> nond_global_evidence: pre-run phase.
>>>>> nond_global_evidence: core run phase.
NonD lhs Samples = 10000 Seed (user-specified) = 59334
>>>>> Identifying minimum and maximum samples for response function 1 within cells 1
through 72
>>>>> Identifying minimum and maximum samples for response function 2 within cells 1
through 72
>>>>> nond_global_evidence: post-run phase.
<<<<< Function evaluation summary: 10000 total (10000 new, 0 duplicate)
ElectricalNetEff: 10000 val (10000 n, 0 d), 0 grad (0 n, 0 d), 0 Hess (0 n, 0 d)
ElectricalNetPower: 10000 val (10000 n, 0 d), 0 grad (0 n, 0 d), 0 Hess (0 n, 0 d)
-----
Belief and Plausibility for each response function:
```

Cumulative Belief/Plausibility Functions (CBF/CPF) for ElectricalNetEff:

Basic Prob Assign	Δ Response Min	Δ Response Max	Cell
-----	-----	-----	----
2.02E-02	1.55E+00	1.65E+00	1
2.69E-02	1.59E+00	1.70E+00	2
2.02E-02	1.62E+00	1.71E+00	3
1.51E-02	1.52E+00	1.65E+00	4
2.02E-02	1.55E+00	1.65E+00	5
1.51E-02	1.58E+00	1.76E+00	6
2.02E-02	1.49E+00	1.59E+00	7
2.69E-02	1.55E+00	1.65E+00	8
2.02E-02	1.57E+00	1.69E+00	9
3.02E-02	1.64E+00	2.39E+00	10
4.03E-02	1.64E+00	2.44E+00	11
3.02E-02	1.71E+00	2.43E+00	12
2.27E-02	1.61E+00	2.35E+00	13
3.02E-02	1.59E+00	2.41E+00	14
2.27E-02	1.74E+00	2.38E+00	15
3.02E-02	1.61E+00	2.31E+00	16
4.03E-02	1.62E+00	2.37E+00	17
3.02E-02	1.69E+00	2.44E+00	18
1.34E-02	1.63E+00	1.73E+00	19
1.79E-02	1.66E+00	1.73E+00	20
1.34E-02	1.69E+00	1.76E+00	21
1.01E-02	1.58E+00	1.66E+00	22
1.34E-02	1.64E+00	1.75E+00	23
1.01E-02	1.66E+00	1.76E+00	24
1.34E-02	1.54E+00	1.65E+00	25
1.79E-02	1.57E+00	1.67E+00	26
1.34E-02	1.63E+00	1.75E+00	27
2.02E-02	1.71E+00	2.38E+00	28
2.69E-02	1.80E+00	2.49E+00	29
2.02E-02	1.80E+00	2.48E+00	30
1.51E-02	1.74E+00	2.39E+00	31
2.02E-02	1.72E+00	2.43E+00	32
1.51E-02	1.78E+00	2.25E+00	33
2.02E-02	1.72E+00	2.36E+00	34
2.69E-02	1.71E+00	2.42E+00	35
2.02E-02	1.70E+00	2.42E+00	36
8.64E-03	1.61E+00	1.71E+00	37
1.15E-02	1.64E+00	1.75E+00	38
8.64E-03	1.70E+00	1.77E+00	39
6.48E-03	1.57E+00	1.66E+00	40
8.64E-03	1.61E+00	1.71E+00	41
6.48E-03	1.65E+00	1.72E+00	42
8.64E-03	1.58E+00	1.65E+00	43
1.15E-02	1.60E+00	1.67E+00	44
8.64E-03	1.63E+00	1.70E+00	45
1.30E-02	1.73E+00	2.39E+00	46
1.73E-02	1.77E+00	2.45E+00	47
1.30E-02	1.81E+00	2.44E+00	48
9.72E-03	1.69E+00	2.38E+00	49
1.30E-02	1.74E+00	2.43E+00	50

9.72E-03	1.83E+00	2.26E+00	51
1.30E-02	1.67E+00	2.39E+00	52
1.73E-02	1.76E+00	2.38E+00	53
1.30E-02	1.67E+00	2.47E+00	54
5.76E-03	1.69E+00	1.72E+00	55
7.68E-03	1.70E+00	1.80E+00	56
5.76E-03	1.75E+00	1.86E+00	57
4.32E-03	1.65E+00	1.71E+00	58
5.76E-03	1.68E+00	1.74E+00	59
4.32E-03	1.73E+00	1.74E+00	60
5.76E-03	1.66E+00	1.67E+00	61
7.68E-03	1.65E+00	1.70E+00	62
5.76E-03	1.68E+00	1.71E+00	63
8.64E-03	1.72E+00	2.43E+00	64
1.15E-02	1.78E+00	2.53E+00	65
8.64E-03	1.90E+00	2.41E+00	66
6.48E-03	1.73E+00	2.32E+00	67
8.64E-03	1.77E+00	2.50E+00	68
6.48E-03	1.99E+00	2.44E+00	69
8.64E-03	1.94E+00	2.46E+00	70
1.15E-02	1.72E+00	2.41E+00	71
8.64E-03	1.77E+00	2.25E+00	72

Δ Response Level	Belief	Δ Response Level	Belief
-----	-----	-----	-----
1.49E+00	1.10E+00	1.64E+00	6.29E-01
1.52E+00	1.08E+00	1.64E+00	5.89E-01
1.54E+00	1.06E+00	1.65E+00	5.75E-01
1.55E+00	1.05E+00	1.65E+00	5.68E-01
1.55E+00	1.02E+00	1.65E+00	5.63E-01
1.55E+00	1.00E+00	1.66E+00	5.57E-01
1.57E+00	9.84E-01	1.66E+00	5.51E-01
1.57E+00	9.64E-01	1.66E+00	5.33E-01
1.57E+00	9.57E-01	1.67E+00	5.23E-01
1.58E+00	9.40E-01	1.67E+00	5.10E-01
1.58E+00	9.24E-01	1.68E+00	4.97E-01
1.58E+00	9.16E-01	1.68E+00	4.91E-01
1.59E+00	9.06E-01	1.69E+00	4.86E-01
1.59E+00	8.79E-01	1.69E+00	4.55E-01
1.60E+00	8.49E-01	1.69E+00	4.42E-01
1.61E+00	8.37E-01	1.69E+00	4.32E-01
1.61E+00	8.28E-01	1.70E+00	4.26E-01
1.61E+00	8.20E-01	1.70E+00	4.19E-01
1.61E+00	7.97E-01	1.70E+00	4.10E-01
1.62E+00	7.67E-01	1.71E+00	3.90E-01
1.62E+00	7.47E-01	1.71E+00	3.70E-01
1.63E+00	7.06E-01	1.71E+00	3.40E-01
1.63E+00	6.93E-01	1.72E+00	3.13E-01
1.63E+00	6.79E-01	1.72E+00	3.01E-01
1.64E+00	6.71E-01	1.72E+00	2.81E-01
1.64E+00	6.59E-01	1.72E+00	2.72E-01

Δ Response Level	Belief	Δ Response Level	Belief
-----	-----	-----	-----
1.73E+00	2.52E-01	1.77E+00	1.29E-01
1.73E+00	2.46E-01	1.78E+00	1.20E-01
1.73E+00	2.41E-01	1.78E+00	1.05E-01
1.74E+00	2.28E-01	1.80E+00	9.35E-02
1.74E+00	2.16E-01	1.80E+00	6.66E-02
1.74E+00	1.93E-01	1.81E+00	4.64E-02
1.75E+00	1.78E-01	1.83E+00	3.35E-02
1.76E+00	1.72E-01	1.90E+00	2.38E-02
1.77E+00	1.55E-01	1.94E+00	1.51E-02
1.77E+00	1.37E-01	1.99E+00	6.48E-03

Δ Response Level	Plausibility	Δ Response Level	Plausibility
-----	-----	-----	-----
1.59E+00	1.10E+00	1.76E+00	6.96E-01
1.65E+00	1.08E+00	1.77E+00	6.82E-01
1.65E+00	1.06E+00	1.80E+00	6.73E-01
1.65E+00	1.03E+00	1.86E+00	6.66E-01
1.65E+00	1.02E+00	2.25E+00	6.60E-01
1.65E+00	1.01E+00	2.25E+00	6.45E-01
1.65E+00	9.91E-01	2.26E+00	6.36E-01
1.66E+00	9.75E-01	2.31E+00	6.27E-01
1.66E+00	9.69E-01	2.32E+00	5.96E-01
1.67E+00	9.59E-01	2.35E+00	5.90E-01
1.67E+00	9.53E-01	2.36E+00	5.67E-01
1.67E+00	9.42E-01	2.37E+00	5.47E-01
1.69E+00	9.24E-01	2.38E+00	5.07E-01
1.70E+00	9.04E-01	2.38E+00	4.97E-01
1.70E+00	8.96E-01	2.38E+00	4.74E-01
1.70E+00	8.69E-01	2.38E+00	4.57E-01
1.71E+00	8.60E-01	2.39E+00	4.37E-01
1.71E+00	8.55E-01	2.39E+00	4.24E-01
1.71E+00	8.50E-01	2.39E+00	4.09E-01
1.71E+00	8.42E-01	2.39E+00	3.78E-01
1.71E+00	8.33E-01	2.41E+00	3.66E-01
1.72E+00	8.13E-01	2.41E+00	3.35E-01
1.72E+00	8.06E-01	2.41E+00	3.27E-01
1.73E+00	8.01E-01	2.42E+00	3.15E-01
1.73E+00	7.87E-01	2.42E+00	2.88E-01
1.74E+00	7.69E-01	2.43E+00	2.68E-01
1.74E+00	7.65E-01	2.43E+00	2.59E-01
1.75E+00	7.59E-01	2.43E+00	2.46E-01
1.75E+00	7.48E-01	2.43E+00	2.16E-01
1.75E+00	7.34E-01	2.44E+00	1.96E-01
1.76E+00	7.21E-01	2.44E+00	1.56E-01
1.76E+00	7.11E-01	2.44E+00	1.49E-01
		2.44E+00	1.19E-01

Δ Response Level	Plausibility
2.45E+00	1.06E-01
2.46E+00	8.88E-02
2.47E+00	8.02E-02
2.48E+00	6.72E-02
2.49E+00	4.70E-02
2.50E+00	2.02E-02
2.53E+00	1.15E-02

Δ Response Level	Belief Prob Level	Plaus Prob Level
1.47E+00	-1.00E-01	-1.00E-01
1.51E+00	-1.00E-01	-7.98E-02
1.54E+00	-1.00E-01	-5.13E-02
1.58E+00	-1.00E-01	8.42E-02
1.62E+00	-7.98E-02	2.53E-01
1.65E+00	2.46E-02	4.43E-01
1.69E+00	7.63E-02	5.74E-01
1.73E+00	1.99E-01	7.48E-01
1.76E+00	3.04E-01	8.45E-01
1.80E+00	3.27E-01	9.33E-01
1.84E+00	3.34E-01	9.76E-01

Probability	Belief Prob Level	Plaus Prob Level
0.00E+00	1.65E+00	1.57E+00
1.00E-01	1.70E+00	1.59E+00
2.00E-01	1.73E+00	1.61E+00
3.00E-01	1.76E+00	1.63E+00
4.00E-01	2.32E+00	1.64E+00
5.00E-01	2.38E+00	1.68E+00
6.00E-01	2.39E+00	1.71E+00
7.00E-01	2.42E+00	1.72E+00
8.00E-01	2.44E+00	1.74E+00
9.00E-01	2.46E+00	1.80E+00
1.00E+00	2.53E+00	1.99E+00

Cumulative Belief/Plausibility Functions (CBF/CPF) for ElectricalNetPower:

Basic Prob Assign	Δ Response Min	Δ Response Max	Cell
2.02E-02	8.75E+01	9.11E+01	1
2.69E-02	8.77E+01	9.23E+01	2
2.02E-02	8.79E+01	9.22E+01	3
1.51E-02	8.31E+01	9.04E+01	4
2.02E-02	8.63E+01	9.05E+01	5
1.51E-02	8.75E+01	9.16E+01	6

2.02E-02	8.27E+01	8.70E+01	7
2.69E-02	8.43E+01	8.99E+01	8
2.02E-02	8.62E+01	9.06E+01	9
3.02E-02	9.03E+01	9.56E+01	10
4.03E-02	8.96E+01	9.66E+01	11
3.02E-02	9.09E+01	9.63E+01	12
2.27E-02	8.73E+01	9.50E+01	13
3.02E-02	8.81E+01	9.51E+01	14
2.27E-02	9.05E+01	9.53E+01	15
3.02E-02	8.61E+01	9.26E+01	16
4.03E-02	8.74E+01	9.46E+01	17
3.02E-02	8.90E+01	9.45E+01	18
1.34E-02	8.63E+01	9.38E+01	19
1.79E-02	8.88E+01	9.34E+01	20
1.34E-02	8.86E+01	9.32E+01	21
1.01E-02	8.58E+01	9.04E+01	22
1.34E-02	8.70E+01	9.29E+01	23
1.01E-02	8.79E+01	9.27E+01	24
1.34E-02	8.41E+01	8.90E+01	25
1.79E-02	8.67E+01	9.04E+01	26
1.34E-02	8.78E+01	9.04E+01	27
2.02E-02	8.93E+01	9.67E+01	28
2.69E-02	9.21E+01	9.77E+01	29
2.02E-02	9.22E+01	9.77E+01	30
1.51E-02	9.03E+01	9.42E+01	31
2.02E-02	9.08E+01	9.54E+01	32
1.51E-02	9.16E+01	9.47E+01	33
2.02E-02	8.87E+01	9.45E+01	34
2.69E-02	8.95E+01	9.45E+01	35
2.02E-02	9.01E+01	9.50E+01	36
8.64E-03	8.96E+01	9.16E+01	37
1.15E-02	9.15E+01	9.46E+01	38
8.64E-03	9.06E+01	9.42E+01	39
6.48E-03	8.58E+01	9.17E+01	40
8.64E-03	8.93E+01	9.28E+01	41
6.48E-03	9.02E+01	9.17E+01	42
8.64E-03	8.62E+01	8.93E+01	43
1.15E-02	8.77E+01	9.12E+01	44
8.64E-03	8.90E+01	9.12E+01	45
1.30E-02	9.22E+01	9.77E+01	46
1.73E-02	9.38E+01	9.83E+01	47
1.30E-02	9.40E+01	9.81E+01	48
9.72E-03	8.97E+01	9.46E+01	49
1.30E-02	9.28E+01	9.66E+01	50
9.72E-03	9.31E+01	9.49E+01	51
1.30E-02	8.96E+01	9.40E+01	52
1.73E-02	9.16E+01	9.52E+01	53
1.30E-02	9.07E+01	9.56E+01	54
5.76E-03	8.96E+01	9.02E+01	55
7.68E-03	9.13E+01	9.56E+01	56
5.76E-03	9.34E+01	9.51E+01	57
4.32E-03	8.88E+01	9.29E+01	58
5.76E-03	9.04E+01	9.34E+01	59
4.32E-03	9.20E+01	9.27E+01	60
5.76E-03	8.59E+01	8.93E+01	61

7.68E-03	9.00E+01	9.21E+01	62
5.76E-03	8.88E+01	9.18E+01	63
8.64E-03	9.17E+01	9.79E+01	64
1.15E-02	9.45E+01	9.98E+01	65
8.64E-03	9.48E+01	9.83E+01	66
6.48E-03	9.11E+01	9.65E+01	67
8.64E-03	9.38E+01	9.86E+01	68
6.48E-03	9.51E+01	9.69E+01	69
8.64E-03	9.16E+01	9.66E+01	70
1.15E-02	9.17E+01	9.61E+01	71
8.64E-03	9.24E+01	9.51E+01	72

Δ Response Level	Belief	Δ Response Level	Belief
-----	-----	-----	-----
8.27E+01	1.10E+00	8.96E+01	4.84E-01
8.31E+01	1.08E+00	8.97E+01	4.44E-01
8.41E+01	1.06E+00	9.00E+01	4.34E-01
8.43E+01	1.05E+00	9.01E+01	4.26E-01
8.58E+01	1.02E+00	9.02E+01	4.06E-01
8.58E+01	1.02E+00	9.03E+01	4.00E-01
8.59E+01	1.01E+00	9.03E+01	3.69E-01
8.61E+01	1.00E+00	9.04E+01	3.54E-01
8.62E+01	9.72E-01	9.05E+01	3.48E-01
8.62E+01	9.63E-01	9.06E+01	3.26E-01
8.63E+01	9.43E-01	9.07E+01	3.17E-01
8.63E+01	9.30E-01	9.08E+01	3.04E-01
8.67E+01	9.09E-01	9.09E+01	2.84E-01
8.70E+01	8.92E-01	9.11E+01	2.54E-01
8.73E+01	8.78E-01	9.13E+01	2.47E-01
8.74E+01	8.55E-01	9.15E+01	2.40E-01
8.75E+01	8.15E-01	9.16E+01	2.28E-01
8.75E+01	8.00E-01	9.16E+01	2.13E-01
8.77E+01	7.80E-01	9.16E+01	1.96E-01
8.77E+01	7.53E-01	9.17E+01	1.87E-01
8.78E+01	7.41E-01	9.17E+01	1.78E-01
8.79E+01	7.28E-01	9.20E+01	1.67E-01
8.79E+01	7.18E-01	9.21E+01	1.63E-01
8.81E+01	6.98E-01	9.22E+01	1.36E-01
8.86E+01	6.67E-01	9.22E+01	1.23E-01
8.87E+01	6.54E-01	9.24E+01	1.03E-01
8.88E+01	6.34E-01	9.28E+01	9.40E-02
8.88E+01	6.16E-01	9.31E+01	8.10E-02
8.88E+01	6.12E-01	9.34E+01	7.13E-02
8.93E+01	5.67E-01	9.38E+01	6.55E-02
8.90E+01	6.06E-01	9.38E+01	5.69E-02
8.93E+01	5.58E-01	9.40E+01	3.96E-02
8.95E+01	5.38E-01	9.45E+01	2.66E-02
8.96E+01	5.11E-01	9.48E+01	1.51E-02
8.96E+01	4.98E-01	9.51E+01	6.48E-03
8.96E+01	4.90E-01		

Δ Response Level	Plausibility	Δ Response Level	Plausibility
-----	-----	-----	-----
8.70E+01	1.10E+00	9.45E+01	6.27E-01
8.90E+01	1.08E+00	9.45E+01	6.06E-01
8.93E+01	1.07E+00	9.45E+01	5.76E-01
8.93E+01	1.06E+00	9.46E+01	5.49E-01
8.99E+01	1.05E+00	9.46E+01	5.40E-01
9.02E+01	1.03E+00	9.46E+01	4.99E-01
9.04E+01	1.02E+00	9.47E+01	4.88E-01
9.04E+01	1.00E+00	9.49E+01	4.73E-01
9.04E+01	9.91E-01	9.50E+01	4.63E-01
9.04E+01	9.76E-01	9.50E+01	4.43E-01
9.05E+01	9.63E-01	9.51E+01	4.20E-01
9.06E+01	9.43E-01	9.51E+01	4.11E-01
9.11E+01	9.22E-01	9.51E+01	3.81E-01
9.12E+01	9.02E-01	9.52E+01	3.75E-01
9.12E+01	8.94E-01	9.53E+01	3.58E-01
9.16E+01	8.82E-01	9.54E+01	3.36E-01
9.16E+01	8.67E-01	9.56E+01	3.15E-01
9.17E+01	8.58E-01	9.56E+01	2.85E-01
9.17E+01	8.52E-01	9.56E+01	2.77E-01
9.18E+01	8.45E-01	9.61E+01	2.64E-01
9.21E+01	8.40E-01	9.63E+01	2.53E-01
9.22E+01	8.32E-01	9.65E+01	2.23E-01
9.23E+01	8.12E-01	9.66E+01	2.16E-01
9.26E+01	7.85E-01	9.66E+01	2.03E-01
9.27E+01	7.55E-01	9.66E+01	1.63E-01
9.27E+01	7.50E-01	9.67E+01	1.54E-01
9.28E+01	7.40E-01	9.69E+01	1.34E-01
9.29E+01	7.32E-01	9.77E+01	1.28E-01
9.29E+01	7.18E-01	9.77E+01	1.01E-01
9.32E+01	7.14E-01	9.77E+01	8.78E-02
9.34E+01	7.00E-01	9.79E+01	6.77E-02
9.34E+01	6.83E-01	9.81E+01	5.90E-02
9.38E+01	6.77E-01	9.83E+01	4.61E-02
9.40E+01	6.63E-01	9.83E+01	3.74E-02
9.42E+01	6.50E-01	9.86E+01	2.02E-02
9.42E+01	6.42E-01	9.98E+01	1.15E-02

Δ Response Level	Belief Prob Level	Plaus Prob Level
-----	-----	-----
8.16E+01	-1.00E-01	-1.00E-01
8.35E+01	-1.00E-01	-6.47E-02
8.53E+01	-1.00E-01	-2.44E-02
8.72E+01	-7.98E-02	1.22E-01
8.91E+01	-6.64E-02	4.33E-01
9.09E+01	7.75E-02	7.16E-01
9.28E+01	2.68E-01	9.06E-01
9.46E+01	4.60E-01	9.85E-01
9.65E+01	7.77E-01	1.00E+00
9.83E+01	9.80E-01	1.00E+00
1.00E+02	1.00E+00	1.00E+00

Probability	Belief Prob Level	Plaus Prob Level
0.00E+00	9.04E+01	8.62E+01
1.00E-01	9.12E+01	8.70E+01
2.00E-01	9.26E+01	8.75E+01
3.00E-01	9.34E+01	8.81E+01
4.00E-01	9.45E+01	8.90E+01
5.00E-01	9.46E+01	8.96E+01
6.00E-01	9.51E+01	9.03E+01
7.00E-01	9.56E+01	9.09E+01
8.00E-01	9.66E+01	9.16E+01
9.00E-01	9.77E+01	9.28E+01
1.00E+00	9.98E+01	9.51E+01

<<<<< Iterator nond_global_evidence completed.

Technology Portfolio 2: Interval Analysis

Technology Portfolio 2 (Tech1 + Tech7+ Tech16+ Tech23+ Tech34)
methodName = nond_global_interval_est
gradientType = none
hessianType = none

>>>>> Running nond_global_interval_est iterator.

NonD lhs Samples = 10000 Seed (system-generated) = 138231

>>>>> Identifying minimum and maximum samples for response function 1
>>>>> Identifying minimum and maximum samples for response function 2
<<<<< Function evaluation summary: 10000 total (10000 new, 0 duplicate)

Min and Max estimated values for each response function:
 Δ ElectricalNetEff: Min = 1.4720000000E+00 Max = 2.5419000000E+00
 Δ ElectricalNetPower: Min = 8.1622000000E+01 Max = 1.0019800000E+02

<<<<< Iterator nond_global_interval_est completed.

Technology Portfolio 1: Dempster-Shafer Theory of Evidence

Technology Portfolio 1 (Tech7+ Tech16)

Writing new restart file dakota.rst
methodName = nond_global_evidence
gradientType = none
hessianType = none

>>>>> Running nond_global_evidence iterator.

>>>>> nond_global_evidence: pre-run phase.

>>>>> nond_global_evidence: core run phase.

NonD lhs Samples = 10000 Seed (user-specified) = 59334

>>>>> Identifying minimum and maximum samples for response function 1 within cells 1 through 9

>>>>> Identifying minimum and maximum samples for response function 2 within cells 1 through 9

>>>>> nond_global_evidence: post-run phase.

<<<<< Function evaluation summary: 10000 total (10000 new, 0 duplicate)

ElectricalNetEff: 10000 val (10000 n, 0 d), 0 grad (0 n, 0 d), 0 Hess (0 n, 0 d)

ElectricalNetPower: 10000 val (10000 n, 0 d), 0 grad (0 n, 0 d), 0 Hess (0 n, 0 d)

Belief and Plausibility for each response function:

Cumulative Belief/Plausibility Functions (CBF/CPF) for ElectricalNetEff:

Basic Prob Assign	Δ Response Min	Δ Response Max	Cell
9.00E-02	5.94E-01	6.43E-01	1.00E+00
6.00E-02	6.07E-01	7.27E-01	2.00E+00
3.00E-02	7.13E-01	9.14E-01	3.00E+00
9.00E-02	9.04E-01	1.41E+00	4.00E+00
3.00E-02	1.40E+00	1.68E+00	5.00E+00
1.50E-01	6.58E-01	7.05E-01	6.00E+00
1.00E-01	6.69E-01	7.91E-01	7.00E+00
5.00E-02	7.74E-01	9.75E-01	8.00E+00
1.50E-01	9.62E-01	1.47E+00	9.00E+00
5.00E-02	1.46E+00	1.74E+00	1.00E+01
6.00E-02	7.00E-01	7.46E-01	1.10E+01
4.00E-02	7.13E-01	8.32E-01	1.20E+01
2.00E-02	8.21E-01	1.02E+00	1.30E+01
6.00E-02	1.01E+00	1.51E+00	1.40E+01
2.00E-02	1.50E+00	1.78E+00	1.50E+01

Δ Response Level	Belief	Δ Response Level	Plausibility
5.94E-01	1.00E+00	6.43E-01	1.00E+00
6.07E-01	9.10E-01	7.05E-01	9.10E-01
6.58E-01	8.50E-01	7.27E-01	7.60E-01
6.69E-01	7.00E-01	7.46E-01	7.00E-01
7.00E-01	6.00E-01	7.91E-01	6.40E-01
7.13E-01	5.40E-01	8.32E-01	5.40E-01
7.13E-01	5.10E-01	9.14E-01	5.00E-01
7.74E-01	4.70E-01	9.75E-01	4.70E-01
8.21E-01	4.20E-01	1.02E+00	4.20E-01
9.04E-01	4.00E-01	1.41E+00	4.00E-01
9.62E-01	3.10E-01	1.47E+00	3.10E-01
1.01E+00	1.60E-01	1.51E+00	1.60E-01
1.40E+00	1.00E-01	1.68E+00	1.00E-01
1.46E+00	7.00E-02	1.74E+00	7.00E-02
1.50E+00	2.00E-02	1.78E+00	2.00E-02

Probability	Belief Prob Level	Plaus Prob Level	
1.00E-01	7.27E-01	6.58E-01	1.89E-02
2.50E-01	7.46E-01	6.69E-01	2.29E-01
5.00E-01	9.75E-01	7.74E-01	5.37E-01
7.50E-01	1.51E+00	1.01E+00	2.28E-01
9.00E-01	1.74E+00	1.46E+00	3.76E-02
1.00E+00	1.78E+00	1.50E+00	

Cumulative Belief/Plausibility Functions (CBF/CPF) for ElectricalNetPower:

Basic Prob Assign	Δ Response Min	Δ Response Max	Cell
9.00E-02	2.90E+01	3.26E+01	1.00E+00
6.00E-02	3.23E+01	3.53E+01	2.00E+00
3.00E-02	3.50E+01	3.76E+01	3.00E+00
9.00E-02	3.73E+01	4.15E+01	4.00E+00
3.00E-02	4.12E+01	4.34E+01	5.00E+00
1.50E-01	3.03E+01	3.39E+01	6.00E+00
1.00E-01	3.36E+01	3.66E+01	7.00E+00
5.00E-02	3.62E+01	3.88E+01	8.00E+00
1.50E-01	3.85E+01	4.28E+01	9.00E+00
5.00E-02	4.25E+01	4.47E+01	1.00E+01
6.00E-02	3.11E+01	3.48E+01	1.10E+01
4.00E-02	3.45E+01	3.74E+01	1.20E+01
2.00E-02	3.72E+01	3.97E+01	1.30E+01
6.00E-02	3.94E+01	4.37E+01	1.40E+01
2.00E-02	4.33E+01	4.55E+01	1.50E+01

Δ Response Level	Belief	Δ Response Level	Plausibility
2.90E+01	1.00E+00	3.26E+01	1.00E+00
3.03E+01	9.10E-01	3.39E+01	9.10E-01
3.11E+01	7.60E-01	3.48E+01	7.60E-01
3.23E+01	7.00E-01	3.53E+01	7.00E-01
3.36E+01	6.40E-01	3.66E+01	6.40E-01
3.45E+01	5.40E-01	3.74E+01	5.40E-01
3.50E+01	5.00E-01	3.76E+01	5.00E-01
3.62E+01	4.70E-01	3.88E+01	4.70E-01
3.72E+01	4.20E-01	3.97E+01	4.20E-01
3.73E+01	4.00E-01	4.15E+01	4.00E-01
3.85E+01	3.10E-01	4.28E+01	3.10E-01
3.94E+01	1.60E-01	4.34E+01	1.60E-01
4.12E+01	1.00E-01	4.37E+01	1.30E-01
4.25E+01	7.00E-02	4.47E+01	7.00E-02
4.33E+01	2.00E-02	4.55E+01	2.00E-02

Probability	Belief Prob Level	Plaus Prob Level
1.00E-01	3.48E+01	3.11E+01
2.50E-01	3.53E+01	3.23E+01
5.00E-01	3.88E+01	3.62E+01
7.50E-01	4.34E+01	3.94E+01
9.00E-01	4.47E+01	4.25E+01
1.00E+00	4.55E+01	4.33E+01

 <<<<< Iterator nond_global_evidence completed.

Technology Portfolio 1: Interval Analysis

Technology Portfolio 1 (Tech7+ Tech16)
 methodName = nond_global_interval_est
 gradientType = none
 hessianType = none

>>>>> Running nond_global_interval_est iterator.

NonD lhs Samples = 10000 Seed (system-generated) = 138231

>>>>> Identifying minimum and maximum samples for response function 1
 >>>>> Identifying minimum and maximum samples for response function 2
 <<<<< Function evaluation summary: 10000 total (10000 new, 0 duplicate)

Min and Max estimated values for each response function:
 ΔElectricalNetEff: Min = 5.94E-01 Max = 1.78E+00
 ΔElectricalNetPower: Min = 2.90E+01 Max = 4.55E+01

<<<<< Iterator nond_global_interval_est completed.

Tech01: Dempster-Shafer Theory of Evidence

Writing new restart file dakota.rst
 methodName = nond_global_evidence
 gradientType = none
 hessianType = none

>>>>> Running nond_global_evidence iterator.

>>>>> nond_global_evidence: pre-run phase.

>>>>> nond_global_evidence: core run phase.

NonD lhs Samples = 10000 Seed (user-specified) = 59334

>>>>> Identifying minimum and maximum samples for response function 1 within cells 1
 through 5
 >>>>> Identifying minimum and maximum samples for response function 2 within cells 1
 through 5
 >>>>> nond_global_evidence: post-run phase.

<<<<< Function evaluation summary: 10000 total (10000 new, 0 duplicate)
 ElectricalNetEff: 10000 val (10000 n, 0 d), 0 grad (0 n, 0 d), 0 Hess (0 n, 0 d)
 ElectricalNetPower: 10000 val (10000 n, 0 d), 0 grad (0 n, 0 d), 0 Hess (0 n, 0 d)

Belief and Plausibility for each response function:
 Cumulative Belief/Plausibility Functions (CBF/CPF) for ElectricalNetEff:

Basic Prob Assign	Δ Response Min	Δ Response Max	Cell
3.00E-01	2.58E-01	2.74E-01	1.00E+00
2.00E-01	2.73E-01	2.89E-01	2.00E+00
1.00E-01	2.89E-01	3.05E-01	3.00E+00
3.00E-01	3.04E-01	3.36E-01	4.00E+00
1.00E-01	3.36E-01	3.52E-01	5.00E+00
Δ Response Level	Belief		
2.58E-01	1.00E+00		
2.73E-01	7.00E-01		
2.89E-01	5.00E-01		
3.04E-01	4.00E-01		
3.36E-01	1.00E-01		
Δ Response Level	Plausibility		
2.74E-01	1.00E+00		
2.89E-01	7.00E-01		
3.05E-01	5.00E-01		
3.36E-01	4.00E-01		
3.52E-01	1.00E-01		
Δ Response Level	Belief Prob Level	Plaus Prob Level	
2.52E-01	1.11E-16	1.11E-16	
2.77E-01	3.00E-01	5.00E-01	
3.02E-01	5.00E-01	6.00E-01	
3.27E-01	6.00E-01	9.00E-01	
4.52E-01	1.00E+00	1.00E+00	
3.52E-01	1.00E+00	1.00E+00	
Probability	Belief Prob Level	Plaus Prob Level	
1.00E-01	2.89E-01	2.73E-01	
2.50E-01	2.89E-01	2.73E-01	
5.00E-01	3.05E-01	2.89E-01	
7.50E-01	3.52E-01	3.36E-01	
9.00E-01	3.52E-01	3.36E-01	
1.00E+00	3.52E-01	3.36E-01	

Cumulative Belief/Plausibility Functions (CBF/CPF) for ElectricalNetPower:

Basic Prob Assign	Δ Response Min	Δ Response Max	Cell
3.00E-01	1.36E+01	1.44E+01	1.00E+00
2.00E-01	1.44E+01	1.51E+01	2.00E+00
1.00E-01	1.51E+01	1.58E+01	3.00E+00
3.00E-01	1.58E+01	1.69E+01	4.00E+00
1.00E-01	1.69E+01	1.74E+01	5.00E+00
Δ Response Level	Belief		
1.36E+01	1.00E+00		
1.44E+01	7.00E-01		
1.51E+01	5.00E-01		
1.58E+01	4.00E-01		
1.69E+01	1.00E-01		
Δ Response Level	Plausibility		
1.44E+01	1.00E+00		
1.51E+01	7.00E-01		
1.58E+01	5.00E-01		
1.69E+01	4.00E-01		
1.74E+01	1.00E-01		
Δ Response Level	Belief Prob Level	Plaus Prob Level	
1.34E+01	1.11E-16	1.11E-16	
1.44E+01	3.00E-01	5.00E-01	
1.54E+01	5.00E-01	6.00E-01	
1.74E+01	9.00E-01	1.00E+00	
1.74E+01	9.00E-01	1.00E+00	
1.84E+01	1.00E+00	1.00E+00	
Probability	Belief Prob Level	Plaus Prob Level	
1.00E-01	1.51E+01	1.44E+01	
2.50E-01	1.51E+01	1.44E+01	
5.00E-01	1.58E+01	1.51E+01	
7.50E-01	1.74E+01	1.69E+01	
9.00E-01	1.74E+01	1.69E+01	
1.00E+00	1.74E+01	1.69E+01	

<<<<< Iterator nond_global_evidence completed.

Tech01: Interval Analysis

methodName = nond_global_interval_est
 gradientType = none
 hessianType = none

```

>>>>> Running nond_global_interval_est iterator.

NonD lhs Samples = 10000 Seed (system-generated) = 138231

>>>>> Identifying minimum and maximum samples for response function 1
>>>>> Identifying minimum and maximum samples for response function 2
<<<<<< Function evaluation summary: 10000 total (10000 new, 0 duplicate)
-----
Min and Max estimated values for each response function:
ΔElectricalNetEff: Min = 2.58E-01 Max = 3.52E-01
ΔElectricalNetPower: Min = 1.36E+01 Max = 1.75E+01
-----
<<<<<< Iterator nond_global_interval_est completed.

```

Tech07: Dempster-Shafer Theory of Evidence

```

Writing new restart file dakota.rst
methodName = nond_global_evidence
gradientType = none
hessianType = none
>>>>> Running nond_global_evidence iterator.
>>>>> nond_global_evidence: pre-run phase.
>>>>> nond_global_evidence: core run phase.
NonD lhs Samples = 10000 Seed (user-specified) = 59334
>>>>> Identifying minimum and maximum samples for response function 1 within cells 1
through 5
>>>>> Identifying minimum and maximum samples for response function 2 within cells 1
through 5
>>>>> nond_global_evidence: post-run phase.
<<<<<< Function evaluation summary: 1000 total (1000 new, 0 duplicate)
ElectricalNetEff: 1000 val (1000 n, 0 d), 0 grad (0 n, 0 d), 0 Hess (0 n, 0 d)
ElectricalNetPower: 1000 val (1000 n, 0 d), 0 grad (0 n, 0 d), 0 Hess (0 n, 0 d)
-----
Belief and Plausibility for each response function:
Cumulative Belief/Plausibility Functions (CBF/CPF) for ElectricalNetEff:

```

Basic Prob Assign	ΔResponse Min	ΔResponse Max	Cell
3.00E-01	3.54E-01	3.75E-01	1.00E+00
2.00E-01	3.74E-01	3.95E-01	2.00E+00
1.00E-01	3.95E-01	4.16E-01	3.00E+00
3.00E-01	4.15E-01	4.57E-01	4.00E+00
1.00E-01	4.57E-01	4.77E-01	5.00E+00

ΔResponse Level	Belief
3.54E-01	1.00E+00
3.74E-01	7.00E-01
3.95E-01	5.00E-01
4.15E-01	4.00E-01
4.57E-01	1.00E-01

Δ Response Level	Plausibility
3.75E-01	1.00E+00
3.95E-01	7.00E-01
4.16E-01	5.00E-01
4.57E-01	4.00E-01
4.77E-01	1.00E-01

Probability	Belief Prob Level	Plaus Prob Level
1.00E-01	3.95E-01	3.74E-01
2.50E-01	3.95E-01	3.74E-01
5.00E-01	4.16E-01	3.95E-01
7.50E-01	4.77E-01	4.57E-01
9.00E-01	4.77E-01	4.57E-01
1.00E+00	4.77E-01	4.57E-01

Cumulative Belief/Plausibility Functions (CBF/CPF) for ElectricalNetPower:

Basic Prob Assign	Δ Response Min	Δ Response Max	Cell
3.00E-01	7.34E+00	7.78E+00	1.00E+00
2.00E-01	7.78E+00	8.21E+00	2.00E+00
1.00E-01	8.21E+00	8.63E+00	3.00E+00
3.00E-01	8.63E+00	9.51E+00	4.00E+00
1.00E-01	9.51E+00	9.93E+00	5.00E+00
Δ Response Level	Belief		
7.34E+00	1.00E+00		
7.78E+00	7.00E-01		
8.21E+00	5.00E-01		
8.63E+00	4.00E-01		
9.51E+00	1.00E-01		

Δ Response Level	Plausibility
7.78E+00	1.00E+00
8.21E+00	7.00E-01
8.63E+00	5.00E-01
9.51E+00	4.00E-01
9.93E+00	1.00E-01

Probability	Belief Prob Level	Plaus Prob Level
1.00E-01	8.21E+00	7.78E+00
2.50E-01	8.21E+00	7.78E+00
5.00E-01	8.63E+00	8.21E+00

```

7.50E-01      9.93E+00      9.51E+00
9.00E-01      9.93E+00      9.51E+00
1.00E+00      9.93E+00      9.51E+00

```

```

-----
<<<<< Iterator nond_global_evidence completed.

```

Tech07: Interval Analysis

```

methodName = nond_global_interval_est
gradientType = none
hessianType = none

```

```

>>>>> Running nond_global_interval_est iterator.

```

```

NonD lhs Samples = 10000 Seed (system-generated) = 138231

```

```

>>>>> Identifying minimum and maximum samples for response function 1
>>>>> Identifying minimum and maximum samples for response function 2
<<<<< Function evaluation summary: 10000 total (10000 new, 0 duplicate)

```

```

-----
Min and Max estimated values for each response function:
ΔElectricalNetEff: Min = 3.54E-01 Max = 4.78E-01
ΔElectricalNetPower: Min = 7.34E+00 Max = 9.93E+00

```

```

-----
<<<<< Iterator nond_global_interval_est completed.

```

Tech16: Dempster-Shafer Theory of Evidence

```

Writing new restart file dakota.rst

```

```

methodName = nond_global_evidence
gradientType = none
hessianType = none

```

```

>>>>> Running nond_global_evidence iterator.

```

```

>>>>> nond_global_evidence: pre-run phase.

```

```

>>>>> nond_global_evidence: core run phase.

```

```

NonD lhs Samples = 10000 Seed (user-specified) = 59334

```

```

>>>>> Identifying minimum and maximum samples for response function 1 within cells 1
through 5

```

```

>>>>> Identifying minimum and maximum samples for response function 2 within cells 1
through 5

```

```

>>>>> nond_global_evidence: post-run phase.

```

```

<<<<< Function evaluation summary: 10000 total (10000 new, 0 duplicate)
ElectricalNetEff: 10000 val (10000 n, 0 d), 0 grad (0 n, 0 d), 0 Hess (0 n, 0 d)
ElectricalNetPower: 10000 val (10000 n, 0 d), 0 grad (0 n, 0 d), 0 Hess (0 n, 0 d)

```

```

-----
Belief and Plausibility for each response function:
Cumulative Belief/Plausibility Functions (CBF/CPF) for ElectricalNetEff:

```

Basic Prob Assign	ΔResponse Min	ΔResponse Max	Cell
-----	-----	-----	----
3.00E-01	2.27E-01	2.66E-01	1.00E+00

2.00E-01	2.34E-01	3.34E-01	2.00E+00
1.00E-01	3.34E-01	5.26E-01	3.00E+00
3.00E-01	5.26E-01	1.05E+00	4.00E+00
1.00E-01	1.05E+00	1.34E+00	5.00E+00

Δ Response Level	Belief
-----	-----
2.27E-01	1.00E+00
2.34E-01	7.00E-01
3.34E-01	5.00E-01
5.26E-01	4.00E-01
1.05E+00	1.00E-01

Δ Response Level	Plausibility
-----	-----
2.66E-01	1.00E+00
3.34E-01	7.00E-01
5.26E-01	5.00E-01
1.05E+00	4.00E-01
1.34E+00	1.00E-01

Probability	Belief Prob Level	Plaus Prob Level
-----	-----	-----
1.00E-01	3.34E-01	2.34E-01
2.50E-01	3.34E-01	2.34E-01
5.00E-01	5.26E-01	3.34E-01
7.50E-01	1.34E+00	1.05E+00
9.00E-01	1.34E+00	1.05E+00
1.00E+00	1.34E+00	1.05E+00

Cumulative Belief/Plausibility Functions (CBF/CPF) for ElectricalNetPower:

Basic Prob Assign	Δ Response Min	Δ Response Max	Cell
-----	-----	-----	----
3.00E-01	2.15E+01	2.49E+01	1.00E+00
2.00E-01	2.49E+01	2.75E+01	2.00E+00
1.00E-01	2.75E+01	2.98E+01	3.00E+00
3.00E-01	2.98E+01	3.38E+01	4.00E+00
1.00E-01	3.38E+01	3.57E+01	5.00E+00

Δ Response Level	Belief
-----	-----
2.15E+01	1.00E+00
2.49E+01	7.00E-01
2.75E+01	5.00E-01
2.98E+01	4.00E-01
3.38E+01	1.00E-01

Δ Response Level	Plausibility		
2.49E+01	1.00E+00		
2.75E+01	7.00E-01		
2.98E+01	5.00E-01		
3.38E+01	4.00E-01		
3.57E+01	1.00E-01		
Probability	Belief Prob Level	Plaus Prob Level	
1.00E-01	2.75E+01	2.49E+01	
2.50E-01	2.75E+01	2.49E+01	
5.00E-01	2.98E+01	2.75E+01	
7.50E-01	3.57E+01	3.38E+01	
9.00E-01	3.57E+01	3.38E+01	
1.00E+00	3.57E+01	3.38E+01	

 <<<<< Iterator nond_global_evidence completed.

Tech16: Interval Analysis

methodName = nond_global_interval_est
 gradientType = none
 hessianType = none

>>>>> Running nond_global_interval_est iterator.

NonD lhs Samples = 10000 Seed (system-generated) = 138231

>>>>> Identifying minimum and maximum samples for response function 1
 >>>>> Identifying minimum and maximum samples for response function 2
 <<<<< Function evaluation summary: 10000 total (10000 new, 0 duplicate)

 Min and Max estimated values for each response function:
 Δ ElectricalNetEff: Min = 2.27E-01 Max = 1.34E+00
 Δ ElectricalNetPower: Min = 2.15E+01 Max = 3.57E+01

 <<<<< Iterator nond_global_interval_est completed.

Tech23: Dempster-Shafer Theory of Evidence

Writing new restart file dakota.rst
 methodName = nond_global_evidence
 gradientType = none
 hessianType = none
 >>>>> Running nond_global_evidence iterator.
 >>>>> nond_global_evidence: pre-run phase.
 >>>>> nond_global_evidence: core run phase.
 NonD lhs Samples = 10000 Seed (user-specified) = 59334

>>>>> Identifying minimum and maximum samples for response function 1 within cells 1 through 5

>>>>> Identifying minimum and maximum samples for response function 2 within cells 1 through 5

>>>>> nond_global_evidence: post-run phase.

<<<<< Function evaluation summary: 10000 total (10000 new, 0 duplicate)

ElectricalNetEff: 10000 val (10000 n, 0 d), 0 grad (0 n, 0 d), 0 Hess (0 n, 0 d)

ElectricalNetPower: 10000 val (10000 n, 0 d), 0 grad (0 n, 0 d), 0 Hess (0 n, 0 d)

Belief and Plausibility for each response function:

Cumulative Belief/Plausibility Functions (CBF/CPF) for ElectricalNetEff:

Basic Prob Assign	Δ Response Min	Δ Response Max	Cell
1.00E-01	2.95E-01	3.16E-01	1.00E+00
2.00E-01	2.73E-01	2.95E-01	2.00E+00
2.00E-01	2.53E-01	2.73E-01	3.00E+00
2.00E-01	2.09E-01	2.52E-01	4.00E+00
3.00E-01	1.88E-01	2.10E-01	5.00E+00

Δ Response Level	Belief
1.88E-01	1.00E+00
2.09E-01	7.00E-01
2.53E-01	5.00E-01
2.73E-01	3.00E-01
2.95E-01	1.00E-01

Δ Response Level	Plausibility
2.10E-01	1.00E+00
2.52E-01	7.00E-01
2.73E-01	5.00E-01
2.95E-01	3.00E-01
3.16E-01	1.00E-01

Probability	Belief Prob Level	Plaus Prob Level
0.00E+00	2.10E-01	1.88E-01
1.00E-01	2.52E-01	2.09E-01
2.00E-01	2.52E-01	2.09E-01
3.00E-01	2.52E-01	2.09E-01
4.00E-01	2.73E-01	2.53E-01
5.00E-01	2.73E-01	2.53E-01
6.00E-01	2.95E-01	2.73E-01
7.00E-01	2.95E-01	2.73E-01
8.00E-01	3.16E-01	2.95E-01
9.00E-01	3.16E-01	2.95E-01
1.00E+00	3.16E-01	2.95E-01

Cumulative Belief/Plausibility Functions (CBF/CPF) for ElectricalNetPower:

Basic Prob Assign	Δ Response Min	Δ Response Max	Cell
1.00E-01	2.09E+01	2.24E+01	1.00E+00
2.00E-01	1.94E+01	2.09E+01	2.00E+00
2.00E-01	1.79E+01	1.94E+01	3.00E+00
2.00E-01	1.48E+01	1.78E+01	4.00E+00
3.00E-01	1.33E+01	1.48E+01	5.00E+00

Δ Response Level	Belief
1.33E+01	1.00E+00
1.48E+01	7.00E-01
1.79E+01	5.00E-01
1.94E+01	3.00E-01
2.09E+01	1.00E-01

Δ Response Level	Plausibility
1.48E+01	1.00E+00
1.78E+01	7.00E-01
1.94E+01	5.00E-01
2.09E+01	3.00E-01
2.24E+01	1.00E-01

Probability	Belief Prob Level	Plaus Prob Level
0.00E+00	1.48E+01	1.33E+01
1.00E-01	1.78E+01	1.48E+01
2.00E-01	1.78E+01	1.48E+01
3.00E-01	1.78E+01	1.48E+01
4.00E-01	1.94E+01	1.79E+01
5.00E-01	1.94E+01	1.79E+01
6.00E-01	2.09E+01	1.94E+01
7.00E-01	2.09E+01	1.94E+01
8.00E-01	2.24E+01	2.09E+01
9.00E-01	2.24E+01	2.09E+01
1.00E+00	2.24E+01	2.09E+01

<<<<< Iterator nond_global_evidence completed.

Tech23: Interval Analysis

Technology Portfolio 2 (Tech1 + Tech7+ Tech16+ Tech23+ Tech34): Interval Analysis
 methodName = nond_global_interval_est
 gradientType = none
 hessianType = none

>>>>> Running nond_global_interval_est iterator.

NonD lhs Samples = 10000 Seed (system-generated) = 138231

>>>> Identifying minimum and maximum samples for response function 1
>>>> Identifying minimum and maximum samples for response function 2
<<<<< Function evaluation summary: 10000 total (10000 new, 0 duplicate)

Min and Max estimated values for each response function:
 Δ ElectricalNetEff: Min = 1.88E-01 Max = 3.16E-01
 Δ ElectricalNetPower: Min = 1.33E+01 Max = 2.24E+01

<<<<< Iterator nond_global_interval_est completed.

Tech34: Dempster-Shafer Theory of Evidence

Writing new restart file dakota.rst
methodName = nond_global_evidence
gradientType = none
hessianType = none
>>>> Running nond_global_evidence iterator.
>>>> nond_global_evidence: pre-run phase.
>>>> nond_global_evidence: core run phase.
NonD lhs Samples = 10000 Seed (user-specified) = 59334
>>>> Identifying minimum and maximum samples for response function 1 within cells 1
through 5
>>>> Identifying minimum and maximum samples for response function 2 within cells 1
through 5
>>>> nond_global_evidence: post-run phase.
<<<<< Function evaluation summary: 10000 total (10000 new, 0 duplicate)
ElectricalNetEff: 10000 val (10000 n, 0 d), 0 grad (0 n, 0 d), 0 Hess (0 n, 0 d)
ElectricalNetPower: 10000 val (10000 n, 0 d), 0 grad (0 n, 0 d), 0 Hess (0 n, 0 d)

Belief and Plausibility for each response function:
Cumulative Belief/Plausibility Functions (CBF/CPF) for ElectricalNetEff:

Basic Prob Assign	Δ Response Min	Δ Response Max	Cell
3.00E-01	5.69E-01	5.98E-01	1.00E+00
2.00E-01	5.98E-01	6.24E-01	2.00E+00
1.00E-01	6.25E-01	6.52E-01	3.00E+00
3.00E-01	6.52E-01	7.07E-01	4.00E+00
1.00E-01	7.07E-01	7.35E-01	5.00E+00

Δ Response Level	Belief
5.69E-01	1.00E+00
5.98E-01	7.00E-01
6.25E-01	5.00E-01
6.52E-01	4.00E-01
7.07E-01	1.00E-01

Δ Response Level	Plausibility		
-----	-----		
5.98E-01	1.00E+00		
6.24E-01	7.00E-01		
6.52E-01	5.00E-01		
7.07E-01	4.00E-01		
7.35E-01	1.00E-01		
Probability	Belief Prob Level	Plaus Prob Level	
-----	-----	-----	
1.00E-01	6.24E-01	5.98E-01	
2.50E-01	6.24E-01	5.98E-01	
5.00E-01	6.52E-01	6.25E-01	
7.50E-01	7.35E-01	7.07E-01	
9.00E-01	7.35E-01	7.07E-01	
1.00E+00	7.35E-01	7.07E-01	

Cumulative Belief/Plausibility Functions (CBF/CPF) for ElectricalNetPower:

Basic Prob Assign	Δ Response Min	Δ Response Max	Cell
-----	-----	-----	----
3.00E-01	3.10E+01	3.57E+01	1.00E+00
2.00E-01	3.57E+01	3.94E+01	2.00E+00
1.00E-01	3.94E+01	4.22E+01	3.00E+00
3.00E-01	4.22E+01	4.62E+01	4.00E+00
1.00E-01	4.62E+01	4.76E+01	5.00E+00
Δ Response Level	Belief		
-----	-----		
3.10E+01	1.00E+00		
3.57E+01	7.00E-01		
3.94E+01	5.00E-01		
4.22E+01	4.00E-01		
4.62E+01	1.00E-01		
Δ Response Level	Plausibility		
-----	-----		
3.57E+01	1.00E+00		
3.94E+01	7.00E-01		
4.22E+01	5.00E-01		
4.62E+01	4.00E-01		
4.76E+01	1.00E-01		
Probability	Belief Prob Level	Plaus Prob Level	
-----	-----	-----	
1.00E-01	3.94E+01	3.57E+01	

2.50E-01	3.94E+01	3.57E+01
5.00E-01	4.22E+01	3.94E+01
7.50E-01	4.76E+01	4.62E+01
9.00E-01	4.76E+01	4.62E+01
1.00E+00	4.76E+01	4.62E+01

<<<<< Iterator nond_global_evidence completed.

Tech34: Interval Analysis

methodName = nond_global_interval_est
gradientType = none
hessianType = none

>>>>> Running nond_global_interval_est iterator.

NonD lhs Samples = 10000 Seed (system-generated) = 138231

>>>>> Identifying minimum and maximum samples for response function 1

>>>>> Identifying minimum and maximum samples for response function 2

<<<<< Function evaluation summary: 10000 total (10000 new, 0 duplicate)

Min and Max estimated values for each response function:

Δ ElectricalNetEff: Min = 5.69E-01 Max = 7.35E-01

Δ ElectricalNetPower: Min = 3.10E+01 Max = 4.76E+01

<<<<< Iterator nond_global_interval_est completed.

REFERENCES

1. Diaper, D., *Knowledge elicitation : principles, techniques, and applications*. Ellis Horwood books in information technology 1989, Chichester, West Sussex, England; New York: E. Horwood ; Halsted Press. 270 p.
2. *Dictionary*. Dictionary.com Unabridged; Available from: <http://dictionary.reference.com/browse/dictionary>.
3. Ayyub, B.M., *Philosophical and Theoretical Bases for Analyzing and Modeling Uncertainty and Ignorance*. Applied Research in Uncertainty Modeling and Analysis, 2005: p. 1-18.
4. Sober, E., *Core Questions in Philosophy* 1991, New York: MacMillan Publishing.
5. Gettier, E.L., *Is justified true belief knowledge?* Analysis, 1963. **23**(6): p. 121-123.
6. Honderich, T., *The Oxford companion to philosophy* 2005: Oxford University Press, USA.
7. Ayyub, B.M., *Ignorance Analysis for Discovery and Knowledge Construction*, 2003, Air Force Office of Scientific Research: Arlington, Virginia.
8. Ayyub, B.M. and M.M. Gupta, *Uncertainty modelling and analysis: theory and applications*. Machine intelligence & pattern recognition 1994, Amsterdam, New York: Elsevier. xx., 537 p.
9. Ayyub, B.M. and G.J. Klir, *Uncertainty modeling and analysis in engineering and the sciences* 2006, Boca Raton, FL: Chapman & Hall/CRC. 378 p.
10. Ayyub, B.M., *From dissecting ignorance to solving algebraic problems*. Reliability Engineering & System Safety, 2004. **85**(1-3): p. 223-238.
11. diCarlo, C.W., *Evolutionary epistemology and the concept of ignorance*, 1998, University of Waterloo: Ontario, Canada.
12. Wood, L. and J. Ford, *Structuring interviews with experts during knowledge elicitation*. International Journal of Intelligent Systems, 1993. **8**(1): p. 71-90.
13. Cooke, R., *Experts in uncertainty: opinion and subjective probability in science* 1991: Oxford University Press, USA.
14. Ramsey, F., *Truth and probability (1926)*. The Foundations of Mathematics and other Logical Essays, 1931.
15. Dalkey, N. and O. Helmer, *An experimental application of the Delphi method to the use of experts*. Management science, 1963: p. 458-467.
16. Lindley, D., *introduction to probability and statistics from bayesian viewpoint. part 2 inference* 1965: CUP Archive.
17. Ayyub, B.M., *Elicitation of expert opinions for uncertainty and risks* 2001, Boca Raton, Fla.: CRC Press. 302 p.
18. DeGroot, M., *Optimal statistical decisions*, 1970, McGraw-Hill, New York.
19. Preyssl, C. and R. Cooke. *Expert Judgment: Subjective and Objective Data for Risk Analysis of Spaceflight Systems*.
20. Savage, L., *Elicitation of personal probabilities and expectations*. Journal of the American Statistical Association, 1971. **66**(336): p. 783-801.
21. Klir, G.J. and M.J. Wierman, *Uncertainty-based information: Elements of generalized information theory* 1999: Springer Verlag.

22. Parsons, S., *Qualitative methods for reasoning under uncertainty* 2001: The MIT Press.
23. Schlesinger, S., et al., *Terminology for model credibility*. Simulation, 1979. **32**(3): p. 103-104.
24. Oberkampf, W.L., et al., *Error and uncertainty in modeling and simulation*. Reliability Engineering & System Safety, 2002. **75**(3): p. 333-357.
25. Oberkampf, W.L., et al., *Variability, uncertainty, and error in computational simulation*. ASME-PUBLICATIONS-HTD, 1998. **357**: p. 259-272.
26. Swiler, L.P., et al., *Epistemic Uncertainty in the Calculation of Margins*, in *50th AIAA/ASME/ASCE/AHS/ASC Structures, Structural Dynamics, and Materials Conference* 2009: Palm Springs, California.
27. Oberkampf, W.L. *Uncertainty Quantification Using Evidence Theory*. in *Advanced Simulation & Computing Workshop*. 2005. Stanford University, Stanford, California.
28. Helton, J.C., et al., *A sampling-based computational strategy for the representation of epistemic uncertainty in model predictions with evidence theory*. Computer Methods in Applied Mechanics and Engineering, 2007. **196**(37-40): p. 3980-3998.
29. Helton, J.C., J.D. Johnson, and W.L. Oberkampf, *An exploration of alternative approaches to the representation of uncertainty in model predictions*. Reliability Engineering & System Safety, 2004. **85**(1-3): p. 39-71.
30. Savage, I.R., *Statistics: uncertainty and behavior* 1968, Boston: Houghton Mifflin Company.
31. De Finetti, B., *Theory of Probability, vol. 1*. John Wiley & Sons 1974, London.
32. Morgan, M.G., M. Henrion, and M. Small, *Uncertainty: a guide to dealing with uncertainty in quantitative risk and policy analysis* 1990: Cambridge University Press.
33. Bernardo, J.M., et al., *Bayesian statistics*. Encyclopedia of Life Support Systems (EOLSS), 2002.
34. Dubois, D. and H. Prade, *Possibility Theory: Qualitative and Quantitative Aspects in Handbook of Defeasible Reasoning and Uncertainty Management Systems: Quantified representation of uncertainty and imprecision*, D.M. Gabbay and P. Smets, Editors. 1998, Springer.
35. Yen, J. and R. Langari, *Fuzzy Logic: Intelligence, Control, and Information* 1998: Prentice Hall.
36. Ayyub, B.M., *Uncertainty modeling and analysis in civil engineering* 1998, Boca Raton: CRC Press. 506 p.
37. Queipo, N.V., et al., *Surrogate-based analysis and optimization*. Progress in Aerospace Sciences, 2005. **41**(1): p. 1-28.
38. Helton, J., et al., *Performance assessment in support of the 1996 compliance certification application for the Waste Isolation Pilot Plant*. Risk Analysis, 1999. **19**(5): p. 959-986.
39. deCooman, G., *Possibility Theory Part I: Measure and Integral-theoretic Ground-work*. International Journal of General Systems, 1997. **25**(4): p. 291-371.
40. Ben-Haim, Y. and I. Elishakoff, *Convex models of uncertainty in applied mechanics*. Vol. 112. 1990: Elsevier Amsterdam.

41. Ben-Haim, Y., *Convex models of uncertainty: Applications and Implications*. Erkenntnis, 1994. **41**(2): p. 139-156.
42. Ben-Haim, Y., *Uncertainty, probability and information-gaps*. Reliability Engineering & System Safety, 2004. **85**(1-3): p. 249-266.
43. Von Mises, R., *Probability, statistics, and truth* 1981, New York: Dover Publications, Inc.
44. Galbraith, J.R., *Designing complex organizations* 1973: Addison-Wesley Longman Publishing Co., Inc. Boston, MA, USA.
45. Laufer, A., *Simultaneous management: managing projects in a dynamic environment* 1997, New York: AMACOM, American Management Association.
46. Hipel, K.W. and Y. Ben-Haim, *Decision making in an uncertain world: Information-gap modeling in water resources management*. IEEE Transactions on Systems, Man, and Cybernetics, Part C: Applications and Reviews, 1999. **29**(4): p. 506-517.
47. Yager, R.R., L. Liu, and SpringerLink, *Classic works of the Dempster-Shafer theory of belief functions* 2008: Springer.
48. Yager, R., J. Kacprzyk, and M. Fedrizzi, *Advances in the Dempster-Shafer theory of evidence* 1994: John Wiley & Sons, Inc. New York, NY, USA.
49. Bae, H.R., R.V. Grandhi, and R.A. Canfield, *Uncertainty quantification of structural response using evidence theory*. AIAA journal, 2003. **41**(10): p. 2062-2068.
50. Guan, J.W. and D.A. Bell, *Evidence theory and its applications*. Studies in computer science and artificial intelligence 1991, Amsterdam ; New York: North-Holland; Elsevier Science Pub. Co. v.
51. Sentz, K. and S. Ferson, *Combination of evidence in Dempster-Shafer theory*, 2002, Sandia National Laboratories.
52. Yager, R.R., *On the Dempster-Shafer framework and new combination rules*. Information sciences, 1987. **41**(2): p. 93-137.
53. Yager, R.R., *Quasi-associative operations in the combination of evidence*. Kybernetes, 1987. **16**(1): p. 37-41.
54. Inagaki, T., *Interdependence between safety-control policy and multiple-sensor schemes via Dempster-Shafer theory*. Reliability, IEEE Transactions on, 1991. **40**(2): p. 182-188.
55. Zhang, L. *Representation, independence, and combination of evidence in the Dempster-Shafer theory*. 1994. John Wiley & Sons, Inc.
56. Dubois, D. and H. Prade, *A set-theoretic view of belief functions: logical operations and approximations by fuzzy sets*. International Journal of General Systems, 1986. **12**(3): p. 193-226.
57. Dubois, D. and H. Prade, *On the combination of evidence in various mathematical frameworks*. Reliability data collection and analysis, 1992. **213241**.
58. Shafer, G., *A mathematical theory of evidence*. Vol. 1. 1976: Princeton university press Princeton, NJ.
59. Ferson, S. and V. Kreinovich, *Representation, propagation, and aggregation of uncertainty*. SAND Report [in progress], 2002.

60. Helton, J.C., et al., *Representation of analysis results involving aleatory and epistemic uncertainty*. International Journal of General Systems, 2010. **39**(6): p. 605-646.
61. Helton, J.C., *Conceptual and computational basis for the quantification of margins and uncertainty*, 2009, Sandia National Laboratories.
62. Clemen, R. and T. Reilly, *Making hard decisions with DecisionTools Suite1999*: Duxbury/Thomson Learning.
63. Phillips, L., *Group elicitation of probability distributions: Are many heads better than one*. Decision science and technology: Reflections on the contributions of Ward Edwards, 1999: p. 313–330.
64. Sigurdsson, J., L. Walls, and J. Quigley, *Bayesian belief nets for managing expert judgement and modelling reliability*. Quality and Reliability Engineering International, 2001. **17**(3): p. 181-190.
65. Shephard, G.G. and C.W. Kirkwood, *Managing the judgmental probability elicitation process: A case study of analyst/manager interaction*. Engineering Management, IEEE Transactions on, 1994. **41**(4): p. 414-425.
66. Garthwaite, P.H., J.B. Kadane, and A. O'Hagan, *Statistical methods for eliciting probability distributions*. Journal of the American Statistical Association, 2005. **100**(470): p. 680-701.
67. Hora, S. and D.V. Winterfeldt, *Nuclear waste and future societies: A look into the deep future*. Technological Forecasting and Social Change, 1997. **56**(2): p. 155-170.
68. Smithson, M., *Ignorance and uncertainty: Emerging paradigms*1989: Springer-Verlag Publishing.
69. Akram, F., M. Prior, and D. Mavris, *An Application of Evidence Theory to Subject Matter Expert based Technology Portfolio Analysis*, in *AIAA Infotech@Aerospace2011*, American Institute of Aeronautics and Astronautics: St. Louis, Missouri.
70. Akram, F., M. Prior, and D. Mavris, *A Comparison between Monte Carlo and Evidence Theory Approaches for Technology Portfolio Planning*, in *AIAA Infotech@Aerospace2011*, American Institute of Aeronautics and Astronautics: St. Louis, Missouri.
71. Akram, F., M. Prior, and D. Mavris. *An improved approach to technology portfolio prioritization process under uncertainty*. in *ASME Turbo Expo 2011*. 2011. Vancouver, Canada: ASME.
72. *NPSS User's Guide*, 1999, Numerical Propulsion System Simulation Consortium.
73. Tong, M.T. and B.A. Naylor, *An Object-Oriented Computer Code for Aircraft Engine Weight Estimation*. GT2008–50062, ASME Turbo-Expo, 2008: p. 9–13.
74. Claus, R., et al., *Numerical propulsion system simulation*. Computing Systems in Engineering, 1991. **2**(4): p. 357-364.
75. Lytle, J., *The numerical propulsion system simulation: A multidisciplinary design system for aerospace vehicles*, in *14th International Symposium on Air Breathing Engines*1999, Citeseer: Florence, Italy.
76. Limbourg, P., et al., *Fault tree analysis in an early design stage using the Dempster-Shafer theory of evidence*. Risk, Reliability and Societal Safety-Aven and Vinnem, 2007.

77. Helton, J.C., F.J. Davis, and J.D. Johnson, *A comparison of uncertainty and sensitivity analysis results obtained with random and Latin hypercube sampling*. Reliability Engineering & System Safety, 2005. **89**(3): p. 305-330.
78. Helton, J.C., et al., *Sensitivity analysis in conjunction with evidence theory representations of epistemic uncertainty*. Reliability Engineering & System Safety, 2006. **91**(10-11): p. 1414-1434.
79. Kirby, M.R. and D.N. Mavris, *Forecasting Technology Uncertainty in Preliminary Aircraft Design*, in *World Aviation Congress and Exposition Congress 1999*, SAE: San Francisco, California.
80. Mavris, D.N. and M.R. Kirby, *Technology Identification, Evaluation, and Selection for Commercial Transport Aircraft*, in *58th Annual Conference of Society of Allied Weight Engineers 1999*: San Jose, California.
81. Kirby, M.R. and D.N. Mavris, *Forecasting the Impact of Technology Infusion on Subsonic Transport Affordability*, in *1998 World Aviation Conference 1998*: Anaheim, California.
82. Kirby, M.R., *A Methodology for Technology Identification, Evaluation, and Selection in Conceptual and Preliminary Aircraft Design*, in *School of Aerospace Engineering 2001*, Georgia Institute of Technology: Atlanta, Georgia.
83. Kirby, M. and D. Mavris, *Forecasting technology uncertainty in preliminary aircraft design*, in *1999 World Aviation Conference 1999*: San Francisco, CA.
84. Mavris, D.N., D.S. Soban, and M.C. Largent, *An Application of a Technology Impact Forecasting (TIF) Method to an Uninhabited Combat Aerial Vehicle*, in *4th World Aviation Congress and Exposition 1999*: San Francisco, CA.
85. Porter, A.L., et al., *A guidebook for technology assessment and impact analysis*. North Holland series in system science and engineering 41980, New York, North Holland. xix, 510 p.
86. Twiss, B.C., *Forecasting for technologists and engineers : a practical guide for better decisions*. IEE management of technology series 1992, Stevenage: Peter Peregrinus Ltd. xv, 221 p.
87. Martino, J.P., *Technological forecasting for decision making*. 3rd ed. McGraw-Hill engineering and technology management series 1993, New York: McGraw-Hill. xvi, 462 p.
88. Akram, F., M. Prior, and D. Mavris, *Improved Technology Impact Modeling Through Technology Synergy Matrices*, in *49th AIAA Aerospace Sciences Meeting Including the New Horizons Forum and Aerospace Exposition 2011*: Orlando, Florida.
89. Akram, F., M. Prior, and D. Mavris, *An Improved Methodology for Gas Turbine Technology Portfolio Planning, Including Technology Synergy Matrices and Real Options Analysis*, in *49th AIAA Aerospace Sciences Meeting Including the New Horizons Forum and Aerospace Exposition 2011*: Orlando, Florida.
90. Shadrack, S.B., et al., *Concept development for future domains a new method of knowledge elicitation*, in *Technical report 11672005*, U.S. Army Research Institute for the Behavioral and Social Sciences: Arlington, VA.
91. Hwang, C. and K. Yoon, *Multiple attribute decision making: methods and applications: a state-of-the-art survey*. Vol. 13. 1981, New York: Springer-Verlag.

92. Deb, K., et al., *A fast and elitist multiobjective genetic algorithm: NSGA-II*. IEEE transactions on evolutionary computation, 2002. **6**(2): p. 182-197.
93. Balasubramanian, P., N. Kulatilaka, and J. Storck, *Managing information technology investments using a real-options approach*. The Journal of Strategic Information Systems, 2000. **9**(1): p. 39-62.
94. Mun, J., *Real options analysis : tools and techniques for valuing strategic investments and decisions*. Wiley finance series 2002, New York: John Wiley & Sons. xxvii, 386 p.
95. Copeland, T.E. and V. Antikarov, *Real options : a practitioner's guide* 2003, New York: Cengage Learning. xi, 370 p.
96. Luehrman, T., *Strategy as a portfolio of real options*. Harvard Business Review, 1998. **76**: p. 89-101.
97. Wang, L., D. Beeson, and G. Wiggs, *A Comparison of Meta-modeling Methods using Practical Industry Requirements*, in *47th AIAA/ASME/ASCE/AHS/ASC Structures, Structural Dynamics, and Materials Conference* 2006: Newport, Rhode Island.
98. Mavris, D.N., Bandte, O., Schrage, D.P., *Application of Probabilistic Methods for the Determination of an Economically Robust HSCT Configuration*, in *AIAA 1996*.
99. Myers, R.H. and D.C. Montgomery, *Response surface methodology : process and product optimization using designed experiments*. 2nd ed. Wiley series in probability and statistics 2002, New York: Wiley. xv, 798 p.
100. Box, G.E.P., Hunter, W.G., Hunter, J.S., *Statistics for Experimenters: An Introduction to Design, Data Analysis, and Model Building* 1978, New York: Wiley & Sons.
101. Mavris, D.N., O. Bandte, and D.P. Schrage. *Application of Probabilistic Methods for the Determination of an Economically Robust HSCT Configuration*, in *AIAA 1996*. in *SAE and AIAA World Aviation Congress*. 1996. Los Angeles, California
102. Sall, J., A. Lehman, and L. Creighton, *JMP start statistics : a guide to statistics and data analysis using JMP and JMP IN software*. 2nd ed 2001, Pacific Grove, CA: Duxbury. xxiv, 491 p.
103. Dobbins, R.C.E.a.R.W., *Neural Networks PC Tools* 1990, San Diego and London: Academic Press.
104. Powell, J.A., *Neural Networks, Neuro-fuzzy and Other Learning Systems for Engineering Applications and Research, Inst. Civ. Eng.* 1994, London: EPSRC.
105. Akram, F., M. Prior, and D. Mavris, *Design Space Exploration of Submerged Inlet Capturing Interaction between Design Parameters*, in *28th AIAA Applied Aerodynamics Conference* 2010, American Institute of Aeronautics and Astronautics: Chicago, Illinois.
106. Arib, M.A., *The Handbook of Brain Theory and Neural Networks, 2nd ed* 2003, Cambridge, Massachusetts, USA: MIT Press.
107. *JMP, Computer Program and Users Manual* 2011, Cary, North Carolina: SAS Institute Inc.
108. Hayter, A.J., *Probability and Statistics for Engineers and Scientists* 2ed 2002: Duxbury.

109. Neter, K., Nachtsheim, and Wasserman, *Applied Linear Statistical Models*. 4 ed1996: Mc Graw Hill.
110. *JMP 9 Pro*, 2010, SAS Institue Inc.
111. *Ultra High Temperature Materials for Turbines*. Available from: http://ec.europa.eu/research/transport/projects/items/ultmat_en.htm.
112. McKay, M.D., R.J. Beckman, and W. Conover, *A comparison of three methods for selecting values of input variables in the analysis of output from a computer code*. Technometrics, 1979: p. 239-245.
113. Iman, R.L., *Latin hypercube sampling*. Encyclopedia of Quantitative Risk Analysis and Assessment, 1999.
114. Helton, J.C. and F.J. Davis, *Latin hypercube sampling and the propagation of uncertainty in analyses of complex systems*. Reliability Engineering & System Safety, 2003. **81**(1): p. 23-69.
115. Helton, J.C., et al., *Sampling-based methods for uncertainty and sensitivity analysis*, in *Technical Report SAND99-22402000*, Sandia National Laboratories: Albuquerque, New Mexico, USA.
116. Huang, D., et al., *Global optimization of stochastic black-box systems via sequential kriging meta-models*. Journal of Global Optimization, 2006. **34**(3): p. 441-466.
117. Jones, D.R., M. Schonlau, and W.J. Welch, *Efficient Global Optimization of Expensive Black-Box Functions*. Journal of Global Optimization, 1998. **13**: p. 455–492.
118. Adams, B.M., et al., *DAKOTA: Version 5.0 User's Manual* 2010, Livermore, California: Sandia National Laboratories.
119. Adams, B.M., et al., *DAKOTA: Version 5.0 Reference Manual* 2010, Livermore, California: Sandia National Laboratories.
120. Ryan, H.M., M.F. Riley, and H. Kobayashi, *Dilute Oxygen Combustion*, 1997, U.S. Department of Energy: Washington, D.C., USA.
121. *Industrial Combustion Technology Roadmap*, 1999, U.S. Department of Energy.
122. <http://www.energy.siemens.com/us/en/power-generation/environmental-system/low-nox-burners-combustion-system-solutions/>. Siemens Energy 2006.
123. <http://turbinesint.com/gas-turbine-compressor-efficiency/>.
124. <https://data.epo.org/publication-server/rest/v1.0/publication-dates/19931006/patents/EP0564135NWA2/document.html>.
125. http://www.rolls-royce.com/technology_innovation/material_tech/high_temperature_materials.jsp.
126. Giampaolo, T., *The gas turbine handbook: Principles and practices*2003: Marcel Dekker Inc.
127. Mankins, J., *Technology readiness levels: A White Paper*, N. Office of Space Access and Technology, Editor 1995.
128. Akram, F. and D.N. Mavris. *Uncertainty Propagation in Technology Valuation Based On Expert Elicitation*. in *50th AIAA Aerospace Sciences Meeting*. 2012. Nashville, Tennessee: The American Institute of Aeronautics and Astronautics (AIAA).

129. Akram, F., *A methodology for uncertainty quantification in quantitative technology valuation based on expert elicitation*, in *School of Aerospace Engineering*2011, Georgia Institute of Technology: Atlanta, Georgia.
130. Inc., S.I., *JMP, Computer Program and Users Manual*, 2011: Cary, North Carolina.
131. Jakeman, J., M. Eldred, and D.B. Xiu, *Numerical approach for quantification of epistemic uncertainty*. *Journal of Computational Physics*, 2010. **229**(12): p. 4648-4663.
132. Akram, F., M. Prior, and D. Mavris, *Improved Submerged Inlet Conceptual Design Process using Data Mining and Surrogate Modeling*, in *AIAA Infotech@Aerospace2010*, American Institute of Aeronautics and Astronautics: Atlanta, Georgia.
133. Zhou, J., *Real options valuation in energy markets*, 2010, Georgia Institute of Technology: Atlanta, Ga.
134. Hansen, C.W., J.C. Helton, and C.J. Sallaberry, *Use of Replicated Latin Hypercube Sampling to Estimate Sampling Variance in Uncertainty and Sensitivity Analysis Results for the Geologic Disposal of Radioactive Waste*. *Procedia - Social and Behavioral Sciences*, 2010. **2**(6): p. 7674-7675.
135. Prior, M.A., et al., *A Design Methodology Enabling the Efficient High-Fidelity Design of Combined Cycle Power Plants*, in *ASME 2009 3rd International Conference on Energy Sustainability*2009, ASME: San Francisco, California.
136. Bradley, T. and J. Fadok. *Advanced hydrogen turbine development update*. in *ASME Turbo Expo 2009: Power for Land, Sea and Air*. 2009. Orlando, Florida, USA.
137. Hetes, B. and H. Richmond, *Expert Elicitation Task Force White Paper*, 2009, U.S. Environmental Protection Agency: Washington, DC, USA.
138. Brosch, R., *Portfolios of real options*. Lecture notes in economics and mathematical systems2008, Berlin: Springer. xvi, 156 p.
139. Ashuri, B., *A real options approach to modeling investments in competitive, dynamic retail markets*, 2008, Georgia Institute of Technology: Atlanta, Ga.
140. Chen, B. and X. Yuan, *Advanced Aerodynamic Optimization System for Turbomachinery*. *Journal of Turbomachinery*, 2008. **130**(2): p. 021005-12.
141. Helton, J.C., et al., *A sampling-based computational of epistemic uncertainty in model strategy for the representation predictions with evidence theory*. *Computer Methods in Applied Mechanics and Engineering*, 2007. **196**(37-40): p. 3980-3998.
142. Guo, J. and X.P. Du, *Sensitivity analysis with mixture of epistemic and aleatory uncertainties*. *Aiaa Journal*, 2007. **45**(9): p. 2337-2349.
143. Taleb, N., *The black swan : the impact of the highly improbable*2007, New York: Random House. xxviii, 366 p.
144. Bunker, R.S., *Gas Turbine Heat Transfer: Ten Remaining Hot Gas Path Challenges*. *Journal of Turbomachinery*, 2007. **129**(2): p. 193-201.
145. Kodukula, P., C. Papudesu, and Books24x7 Inc., *Project valuation using real options a practitioner's guide*, 2006, J. Ross Pub.: Ft. Lauderdale, Fla.
146. Gano, S.E., H. Kim, and D.E.B. II, *Comparison of Three Surrogate Modeling Techniques: Datscaper, Kriging, and Second Order Regression*, in *11th*

- AIAA/ISSMO Multidisciplinary Analysis and Optimization Conference 2006, American Institute of Aeronautics and Astronautics: Portsmouth, Virginia, USA.
147. Schulmerich, M., *Real options valuation : the importance of interest rate modelling in theory and practice*, 2005, Springer,; Berlin ; New York. p. xvi, 357 p.
 148. Brandão, L., J. Dyer, and W. Hahn, *Using binomial decision trees to solve real-option valuation problems*. Decision Analysis, 2005. **2**(2): p. 69-88.
 149. Ferson, S., et al., *Summary from the epistemic uncertainty workshop: consensus amid diversity*. Reliability Engineering & System Safety, 2004. **85**(1-3): p. 355-369.
 150. Roth, B. and C. Patel, *Application of Genetic Algorithms in the Engine Technology Selection Process*. Journal of Engineering for Gas Turbines and Power, 2004. **126**(4): p. 693-700.
 151. Smit, H.T.J. and L. Trigeorgis, *Strategic investment : real options and games* 2004, Princeton, N.J.: Princeton University Press. xxxii, 471 p.
 152. Helton, J.C. and W.L. Oberkampf, *Alternative representations of epistemic uncertainty*. Reliability Engineering & System Safety, 2004. **85**(1-3): p. 1-10.
 153. Soundappan, P., et al., *Comparison of evidence theory and Bayesian theory for uncertainty modeling*. Reliability Engineering & System Safety, 2004. **85**(1-3): p. 295-311.
 154. Mun, J., *Real options analysis course : business cases and software applications* 2003, Hoboken, N.J.: John Wiley. xi, 303 p.
 155. Carlsson, C. and R. Fullér, *A fuzzy approach to real option valuation*. Fuzzy sets and systems, 2003. **139**(2): p. 297-312.
 156. Ayyub, B.M., N.O. Attoh-Okine, and IEEE Computer Society., *ISUMA 2000 Fourth International Symposium on Uncertainty Modeling and Analysis : 21-24 September, 2003, College Park, Maryland, 2003*, IEEE Computer Society Press: Los Alamitos, Calif.
 157. Wilcox, R.C. and B.M. Ayyub. *Uncertainty modeling of data and uncertainty propagation for risk studies*. in *Uncertainty Modeling and Analysis, 2003. ISUMA 2003. Fourth International Symposium on*. 2003.
 158. Ferson, S., et al., *Constructing probability boxes and Dempster-Shafer structures*, 2002, Sandia National Laboratories: Albuquerque, New Mexico.
 159. Schwartz, E.S. and L. Trigeorgis, *Real options and investment under uncertainty : classical readings and recent contributions* 2001, Cambridge, Mass.: MIT Press. viii, 871 p.
 160. Beynon, M., D. Cosker, and D. Marshall, *An expert system for multi-criteria decision making using Dempster Shafer theory*. Expert Systems with Applications, 2001. **20**(4): p. 357-367.
 161. Oberkampf, W.L., J.C. Helton, and K. Sentz, *Mathematical representation of uncertainty*. 42nd AIAA/ASME/ASCE/AHS/ASC Structures, Structural Dynamics, and Materials Conference and Exhibit, 2001.
 162. Pedersen, K., et al. *Validating design methods and research: the validation square*. in *ASME Design Theory and Methodology Conference*. 2000. Baltimore, Maryland.

163. Downing, C., N. Wallace, and U.S. Department of Commerce, *A real options approach to housing investment / by Chris Downing and Nancy Wallace*. Finance & economics discussion series 2000, Washington, DC: U.S. Department of Commerce Federal Reserve Board Division of Research & Statistics and Monetary Affairs;. 38 p.
164. Lytle, J., *The Numerical Propulsion System Simulation: An Overview*, 2000, NASA Scientific and Technical Information Program.
165. Beynon, M., B. Curry, and P. Morgan, *The Dempster-Shafer theory of evidence: an alternative approach to multicriteria decision modelling*. Omega, 2000. **28**(1): p. 37-50.
166. Oberkampf, W.L., et al., *Estimation of Total Uncertainty in Modeling and Simulation*, 2000, Sandia National Laboratories.
167. Alleman, J.H. and E.M. Noam, *The new investment theory of real options and its implication for telecommunications economics*. Topics in regulatory economics and policy series 1999, Boston: Kluwer Academic. xv, 280 p.
168. Amram, M. and N. Kulatilaka, *Real options : managing strategic investment in an uncertain world*. Financial Management Association survey and synthesis series 1999, Boston, Mass.: Harvard Business School Press. x, 246 p.
169. Klir, G.J. *Uncertainty and information measures for imprecise probabilities: An overview*. in *1st International Symposium on Imprecise Probabilities and Their Applications*. 1999. Ghent, Belgium: Citeseer.
170. Helton, J.C., *Uncertainty and sensitivity analysis in the presence of stochastic and subjective uncertainty*. Journal of Statistical Computation and Simulation, 1997. **57**(1-4): p. 3-76.
171. Ayyub, B.M. and R.H. McCuen, *Probability, statistics, & reliability for engineers* 1997, Boca Raton: CRC Press. 514 p.
172. Ayyub, B.M. and M.M. Gupta, *Uncertainty analysis in engineering and sciences : fuzzy logic, statistics, and neural network approach*. International series in intelligent technologies 1997, Boston: Kluwer Academic Publishers. xxiv, 370 p.
173. Veres, J., *Numerical Propulsion System Simulation*, in NASA 1997.
174. Trigeorgis, L., *Real options : managerial flexibility and strategy in resource allocation* 1996, Cambridge, Mass.: MIT Press. xiii, 427 p.
175. Mavris, D.N., Kirby, M.R., *Preliminary Assessment of the Economic Viability of a Family of Very Large Transport Configurations*, 1996, AIAA.
176. Trigeorgis, L., *Real options in capital investment : models, strategies, and applications* 1995, Westport, Conn.: Praeger. xvii, 361 p.
177. Ayyub, B.M. and North American Fuzzy Information Processing Society. Conference, *The Third International Symposium on Uncertainty Modeling and Analysis and Annual Conference of the North American Fuzzy Information Processing Society, September 17-20, 1995, College Park, Maryland* 1995, Los Alamitos, Calif.: IEEE Computer Society Press. xx, 810 p.
178. Helton, J.C., et al., *Uncertainty and sensitivity analysis of chronic exposure results with the MACCS reactor accident consequence model*. Reliability Engineering & System Safety, 1995. **50**(2): p. 137-177.
179. Lai, Y.J., T.Y. Liu, and C.L. Hwang, *Topsis for MODM*. European Journal of Operational Research, 1994. **76**(3): p. 486-500.

180. Rust, R.T. and A.J. Zahorik, *Customer satisfaction, customer retention, and market share*. Journal of Retailing, 1993. **69**(2): p. 193-215.
181. Ayyub, B.M., *Proceedings : Second International Symposium on Uncertainty Modeling and Analysis, April 25-28, 1993, University of Maryland, College Park, Maryland*1993, Los Alamitos, Calif.: IEEE Computer Society Press. xvi, 660 p.
182. Ayyub, B.M., M.M. Gupta, and L.N. Kanal, *Analysis and management of uncertainty : theory and applications*. Machine intelligence and pattern recognition1992, New York, N.Y., U.S.A.: Elsevier Science Pub. Co. xviii, 428 p.
183. Porter, A.L., *Forecasting and management of technology*. Wiley series in engineering & technology management1991, New York: Wiley & Sons. xiv, 448 p.
184. Ayyub, B.M., *Proceedings : First International Symposium on Uncertainty Modeling and Analysis*, 1990, IEEE Computer Society Press: Los Alamitos, Calif. p. xvi, 707 p.
185. McGraw, K. and M. Seale, *Knowledge elicitation with multiple experts: considerations and techniques*. Artificial Intelligence Review, 1988. **2**(1): p. 31-44.
186. Mattingly, J.D., W.H. Heiser, and D.H. Daley, *Aircraft engine design*. AIAA education series1987, New York, N.Y.: American Institute of Aeronautics and Astronautics. xxx, 582 p.
187. Metropolis, N., *The beginning of the Monte Carlo method*. Los Alamos Science, 1987(Special Issue).
188. Wilkin, L. and A. Sutton, *The Management of uncertainty : approaches, methods, and applications*. NATO Advanced Science Institutes series., ed. L. Wilkin and A. Sutton1986, Dordrecht
189. Zadeh, L., *A simple view of the Dempster-Shafer theory of evidence and its implication for the rule of combination*. AI magazine, 1986. **7**(2): p. 85.
190. Davidson, D., *A coherence theory of truth and knowledge*. 1983, 1983: p. 423-38.
191. Dretske, F.I., *Knowledge and the Flow of Information*. The MIT Press Classics Series1983: The MIT Press.
192. Morris, J. and R. D'Amore, *Aggregating and Communicating Uncertainty*, 1980, PATTERN ANALYSIS AND RECOGNITION CORP ROME NY.
193. Armstrong, D.M., *Belief, truth and knowledge*1973: Cambridge Univ Press.
194. *Natural Gas Prices Summary*. Available from: <http://www.eia.gov>.
195. Helton, J.C. and W.L. Oberkampf, *Alternative representations of epistemic uncertainty*. Reliability Engineering & System Safety. **85**(1-3): p. 1-10.
196. Agarwal, H., et al., *Uncertainty quantification using evidence theory in multidisciplinary design optimization*. Reliability Engineering & System Safety. **85**(1-3): p. 281-294.
197. Soundappan, P., et al., *Comparison of evidence theory and Bayesian theory for uncertainty modeling*. Reliability Engineering & System Safety. **85**(1-3): p. 295-311.
198. Rutherford, B., *A response-modeling approach to characterization and propagation of uncertainty specified over intervals*. Reliability Engineering & System Safety. **85**(1-3): p. 211-222.

199. Bier, V., *Implications of the research on expert overconfidence and dependence*. Reliability Engineering & System Safety. **85**(1-3): p. 321-329.
200. Yager, R.R., *Uncertainty modeling and decision support*. Reliability Engineering & System Safety. **85**(1-3): p. 341-354.
201. O'Hagan, A. and J.E. Oakley, *Probability is perfect, but we can't elicit it perfectly*. Reliability Engineering & System Safety. **85**(1-3): p. 239-248.
202. Wong, W. and F. CEng, *How did that happen?: engineering safety and reliability*2002: Professional Engineering.
203. Oberkampf, W.L., et al., *Challenge problems: uncertainty in system response given uncertain parameters*. Reliability Engineering & System Safety, 2004. **85**(1): p. 11-19.
204. Nikolaidis, E., D.M. Ghiocel, and S. Singhal, *Engineering design reliability handbook*2005: CRC.
205. Research, U.N.R.C.O.o.N.R.R.D.o.S., *Severe accident risks: an assessment for five US nuclear power plants*1990: Division of Systems Research, Office of Nuclear Regulatory Research, US Nuclear Regulatory Commission.
206. Modarres, M., *What every engineer should know about reliability and risk analysis*. Vol. 30. 1993: CRC.
207. Kumamoto, H., et al., *Probabilistic risk assessment and management for engineers and scientists*. 1996.
208. Krause, P. and D. Clark, *Representing uncertain knowledge: an artificial intelligence approach*1993: Kluwer Academic Publishers.
209. Hauptmanns, U. and W. Werner, *Engineering risks: Evaluation and valuation*1991: Springer-Verlag.
210. Haimes, Y.Y., *Risk modeling, assessment, and management*2009: Wiley.
211. Ferson, S., et al., *Summary from the epistemic uncertainty workshop: consensus amid diversity*. Reliability Engineering & System Safety, 2004. **85**(1): p. 355-369.
212. Ferson, S. and J.G. Hajagos, *Arithmetic with uncertain numbers: rigorous and (often) best possible answers*. Reliability Engineering & System Safety, 2004. **85**(1): p. 135-152.
213. Cullen, A.C. and H.C. Frey, *Probabilistic techniques in exposure assessment: a handbook for dealing with variability and uncertainty in models and inputs*1999: Springer.
214. Chiles, J.R., *Inviting disaster: lessons from the edge of technology: an inside look at catastrophes and why they happen*2002: Harper Paperbacks.